

# FORUM MOVIE



SOLUZIONI

# TRAS FORM ABILI

L'espressione massima  
dello spazio

*The attention to our well-being can be measured by the details that make **everyday life easier and more pleasant in the spaces we live in.***

*The organization and design of home interiors, as we conceive it in **Atim**, must find a perfect balance between the aesthetics and the functionality of all furnishing elements.*

*The **Trasformabili** collection was born from this premise: to make every space more versatile, modern and welcoming, with furnishing solutions that promptly transform themselves to suit our activities and needs.*

*Solutions for innovative furniture, which increase the usability of environments and enhance the quality of life as an absolute value.*

L'attenzione al benessere si misura nei dettagli che rendono la vita di tutti i giorni più semplice e piacevole negli spazi che abitiamo.

L'organizzazione degli interni, per come la concepiamo in **Atim**, deve trovare un perfetto equilibrio tra la valorizzazione dell'estetica e la funzionalità degli elementi d'arredo.

La collezione **Trasformabili** è nata da questa premessa: rendere ogni spazio più versatile, moderno ed accogliente, con soluzioni d'arredo che si trasformano per assecondare le nostre attività ed esigenze.

Soluzioni per un arredo innovativo, che accresce la fruibilità degli ambienti dove la qualità della vita è un valore assoluto.

# Un'esperienza OMNICHANNEL

**We2You**

## Accorcia i tempi e le distanze con We2You

Il servizio **We2You** è un vero e proprio meeting nella showroom di Atim, unendo il meglio del mondo online e offline.

Grazie ad un esclusivo sistema di telecamere, puoi interagire attivamente con il nostro team e guardare le diverse soluzioni Atim da diverse angolazioni mentre ti guidiamo, in diretta, all'interno della showroom.

## Shorten times and distances with We2You

*The **We2You** service allows you to have an actual meeting at Atim's showroom, combining the best of the online and offline world.*

*Thanks to an exclusive integrated camera system, you can actively interact with our team and analyze the different Atim solutions from different angles while we guide you, live, through the showroom.*

## Rimani sempre aggiornato

Ricevi informazioni aggiornate sui nostri prodotti, servizi e iniziative sulla tua piattaforma preferita:

## Stay up to date

*Follow the updates about our products, services and initiatives on your favorite platform:*



\* Scopri  
il servizio  
e fissa  
un meeting



[atimspa.com/we2you](https://atimspa.com/we2you)

\*Servizio esclusivo per produttori d'arredo, distributori di accessori per l'arredamento e progettisti di contract.

Presenza in oltre 50 paesi, aggiornamenti continui online e servizio We2You

# I **Trasformabili** nel Mondo *across the World*

Le soluzioni Trasformabili Atim sono disponibili in tutto il mondo grazie ad un'ampia rete vendita, fatta da agenti e distributori selezionati con cura, presenti in oltre 50 paesi.

*Atim's solutions are available all over the world thanks to an extensive sales network, made up of carefully selected agents and distributors, present in over 50 countries.*



[atimspa.com](http://atimspa.com)



L'espressione massima dello spazio



FORUM  
FORUM  
FORUM  
FORUM  
FORUM  
FORUM

# INDICE GENERALE

# GENERAL INDEX

## SENZA GAMBA WITHOUT LEG

<b>SIESTA</b>	
Tavolo estraibile da cassetto <i>Pull-out drawer table</i>	<b>10</b>
<b>BRUNCH</b>	
Tavolo estraibile da cassetto <i>Pull-out drawer table</i>	<b>12</b>
<b>COCKTAIL</b>	
Tavolo estraibile da cassetto <i>Pull-out drawer table</i>	<b>14</b>
<b>LUNCH</b>	
Tavolo estraibile da cassetto <i>Pull-out drawer table</i>	<b>16</b>
<b>LUNCH REVERSE</b>	
Tavolo estraibile da cassetto <i>Pull-out drawer table</i>	<b>18</b>

<b>READY</b>	
Tavolo estraibile da cassetto con sistema sincrono: aperto/chiuso <i>Pull-out drawer table with synchronous system: open/close</i>	<b>20</b>

<b>OPLÀ</b>	
Piano estraibile filo ripiano <i>Pull-out top aligned with shelf</i>	<b>22</b>

<b>OPLÀ PIANO ACCIAIO</b>	
Piano estraibile filo ripiano <i>Pull-out top aligned with shelf</i>	<b>24</b>

<b>OPLÀ FOLDING</b>	
<b>OPLÀ FOLDING SMALL</b>	
Piano estraibile filo ripiano <i>Pull-out top aligned with shelf</i>	<b>26</b>

<b>SHOT</b>	
Piano estraibile da cassetto <i>Pull-out drawer worktop</i>	<b>28</b>

<b>SHOT FOLDING</b>	
Piano estraibile da cassetto <i>Pull-out drawer worktop</i>	<b>30</b>

<b>DESK</b>	
Scrivania abbattibile a ribalta <i>Drop-leaf foldaway desk</i>	<b>32</b>

<b>HOMEWORK</b>	
Tavolo abbattibile a soffietto <i>Fold-out table</i>	<b>34</b>

<b>UNIVERSAL</b>	
Piano estraibile da colonna <i>Pull-out column worktop</i>	<b>36</b>

## MULTIFUNZIONE MULTIFUNCTIONAL

<b>UNIVERSAL BOX</b>	
Piano con contenitore estraibile da colonna <i>Pull-out column top with cutlery tray</i>	<b>38</b>

<b>FUNCTIONAL</b>	
Piano con contenitore estraibile da cassetto <i>Pull-out drawer worktop with cutlery tray</i>	<b>40</b>

<b>BLADE</b>	
Tagliere con contenitore estraibile da cassetto <i>Pull-out drawer chopping board with cutlery tray</i>	<b>42</b>

<b>COOK</b>	
Tavolo con tagliere e contenitore estraibile da cassetto <i>Pull-out drawer table with chopping board and cutlery tray</i>	<b>44</b>

## 1 GAMBA 1 LEG

<b>T-TABLE / T-TABLE XL</b>	
Tavolo con gamba singola abbattibile telescopica estraibile da cassetto <i>Pull-out drawer table with single telescopic folding leg</i>	<b>46</b>

<b>T-BENCH / T-BENCH XL</b>	
Seduta con gamba singola abbattibile estraibile da cassetto <i>Pull-out drawer bench with single folding leg</i>	<b>48</b>

<b>JUST</b>	
Piano a ribalta con gamba singola abbattibile telescopica <i>Tilting top with single telescopic folding leg</i>	<b>50</b>

## 2 GAMBE 2 LEGS

<b>PARTY</b>	
Tavolo con gamba doppia abbattibile telescopica estraibile da cassetto <i>Pull-out drawer table with double telescopic folding leg</i>	<b>52</b>

<b>MENSOLA PARTY</b>	
Tavolo con gamba doppia abbattibile telescopica estraibile da cassetto <i>Pull-out drawer table with double telescopic folding leg</i>	<b>54</b>

<b>EVOLUTION</b>	
<b>EVOLUTION XL</b>	
Tavolo con gamba a ponte estraibile da cabinet <i>Pull-out cabinet table with bridg leg</i>	<b>56</b>

## TOP

### OPLÀ TOP

Piano estraibile filo top  
*Pull-out top aligned with counter top* **58**

### SANDWICH

Top estraibile con easybook  
*Pull-out top with easybook* **60**

### FLIP TOP

Piano con easybook estraibile da cassetto  
*Pull-out drawer worktop with easybook* **62**

### BREAKFAST

Piano estraibile  
*Pull-out top* **64**

### BREAKFAST TOP

Piano scorrevole su top  
*Sliding table top* **66**

### SNACK

Piano scorrevole  
*Sliding table top* **68**

### SNACK TOP

Piano scorrevole su top  
*Sliding table top* **70**

### FLAP

Piano scorrevole su top  
*Sliding table top* **72**

### SLIDE

Piano scorrevole su top con apertura diagonale  
*Sliding table top with diagonal opening* **74**

### CORNER

Piano scorrevole su top con apertura diagonale  
*Sliding table top with diagonal opening* **76**

### TWICE TOP

Piano scorrevole su top  
*Sliding table top* **78**

### TOP33

Piano scorrevole su top  
*Sliding table top* **80**

## PENISOLA PENINSULA

### VOILÀ FLAG

Piano estraibile con gambe  
*Pull-out top table with legs* **82**

### VOILÀ CHAIR

Piano estraibile con gambe  
*Pull-out top table with legs* **84**

### VOILÀ CHAIR REVERSE

Piano a ribalta con gambe  
*Foldaway top table with legs* **86**

### DINAMICO DINAMICO+

Piano scorrevole con profilo a gola  
*Sliding top with gola profile* **88**

### SESTANTE

Piano scorrevole e girevole su top  
*Sliding and revolving table top* **90**

## +39

Soluzioni per mobili con profondità di soli 39 cm

*Solutions for furniture with a depth of only 39 cm*

### EVOLUTION +39 EVOLUTION XL +39

Tavolo estraibile da cabinet con gamba a ponte  
*Pull-out cabinet table with bridge leg* **92**

### MENSOLA T-ABLE +39

Tavolo con gamba doppia abbattibile telescopica estraibile da cassetto  
*Pull-out drawer table with double telescopic folding leg* **94**

### T-BENCH +39

Seduta con gamba singola abbattibile estraibile da cassetto  
*Pull-out drawer bench with single folding leg* **96**

### LUNCH +39

Tavolo estraibile da cassetto  
*Pull-out drawer table* **98**

### HOMEWORK +39

Tavolo abbattibile a soffietto  
*Fold-out table* **100**

### OPLÀ +39

Piano estraibile filo ripiano  
*Pull-out top flush with shelf* **102**

### OPLÀ FOLDING +39

Piano estraibile filo ripiano  
*Pull-out top flush with shelf* **104**

### SHOT +39

Piano estraibile da cassetto  
*Pull-out drawer worktop* **106**

### SHOT FOLDING +39

Piano estraibile da cassetto  
*Pull-out drawer worktop* **108**

## LAVANDERIA LAUNDRY

### PRUA

Asse da stiro estraibile  
*Pull-out ironing board* **110**

### PRUA SHORT

Asse da stiro estraibile  
*Pull-out ironing board* **112**

### PRUA LIFT

Asse da stiro a ribalta  
*Tilting ironing board* **114**

### BASKET

Sacco lavanderia con piano estraibile  
*Pull-out laundry bag with top* **116**

# Siesta

TAVOLO ESTRAIBILE DA CASSETTO  
PULL-OUT DRAWER TABLE

## DESIGN

Arch. Giulio Manzoni  
ATIM R&S / ATIM R&D

### FINITURA

#### FINISHING

Anodizzato naturale (Grigio satinato)  
Anodised aluminium (Gray satin)

### PORTATA

#### LOAD CAPACITY

80 Kg equamente distribuiti  
80 Kg evenly distributed

### PACKAGING

118x18x8 cm  
5 Kg  
0,017 m<sup>3</sup>

### SCORRIMENTO

#### SLIDING

Cuscinetti a sfera  
Ball-bearing slide system

### OPTIONAL

su richiesta / on request

### KIT TAPPI

#### KIT CAPS

2.9250551.XX

### CERNIERE

#### HINGES

2.8029912.12



#### NOTE

L'articolo non prevede la fornitura delle parti in legno.  
The item does not include the supply of wooden parts.

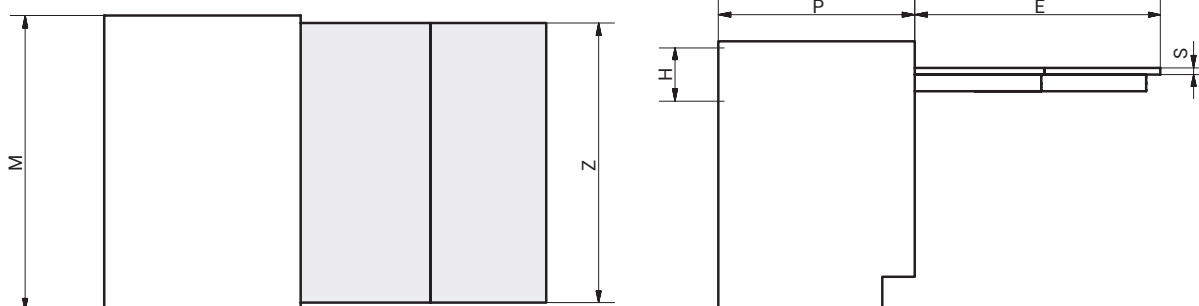

CODICE CODE	M	P min	H min	S1	E	Z min	S min
411/78.1155.22	450	550	120	15/20	750	405	16
411/78.1150.22	600	550	120	15/20	750	555	16
411/78.1160.22	900	550	120	15/20	750	855	16
411/78.1170.22	1200	550	120	15/20	750	1155	16

Valori espressi in millimetri. Value expressed in millimetres.

Legenda tabella e riferimenti optional a pagina 118. Key to table and optional references on page 118



# Brunch

TAVOLO ESTRAIBILE DA CASSETTO  
PULL-OUT DRAWER TABLE

## DESIGN

Arch. Giulio Manzoni  
ATIM R&S / ATIM R&D

### FINITURA

#### FINISHING

Anodizzato naturale (Grigio satinato)  
Anodised aluminium (Gray satin)

### PORTATA

#### LOAD CAPACITY

80 Kg equamente distribuiti  
80 Kg evenly distributed

### PACKAGING

118x18x8 cm  
8,5 Kg  
0,017 m<sup>3</sup>

### OPTIONAL

su richiesta / on request

### KIT TAPPI

#### KIT CAPS

2.9251521.XX

### CERNIERE

#### HINGES

2.8029912.12



### NOTE

L'articolo non prevede la fornitura delle parti in legno.  
The item does not include the supply of wooden parts.

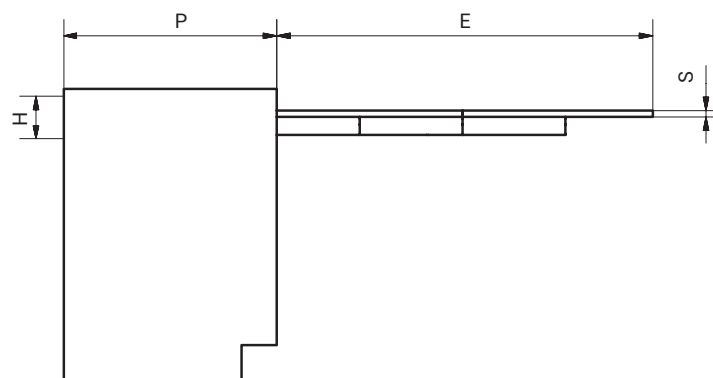
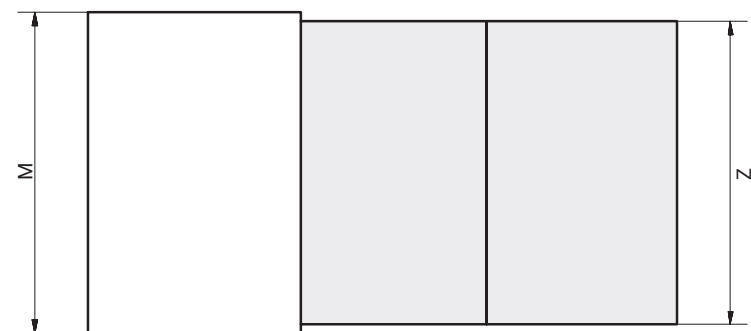

CODICE CODE	M	P min	H min	S1	E	Z min	S min
411/78.1100.22	600	540	120	15/20	1060	555	16
411/78.1110.22	900	540	120	15/20	1060	855	16
411/78.1120.22	1200	540	120	15/20	1060	1155	16

Valori espressi in millimetri. Value expressed in millimetres.

Legenda tabella e riferimenti optional a pagina 118. Key to table and optional references on page 118



# Cocktail

TAVOLO ESTRAIBILE DA CASSETTO  
PULL-OUT DRAWER TABLE

## FINITURA

### FINISHING

Inox Bronzino

## PORTATA

### LOAD CAPACITY

60 Kg equamente distribuiti

60 Kg evenly distributed

## PACKAGING

118x18x8 cm

3,8 Kg

0,017 m<sup>3</sup>

## SCORRIMENTO

### SLIDING

Alluminio / Alluminio

Aluminium / Aluminium

## OPTIONAL

su richiesta / on request

## KIT TAPPI

### KIT CAPS

2.9247221.XX

## CERNIERE

### HINGES

2.8029912.12

## DESIGN

Arch. Giulio Manzoni

ATIM R&S / ATIM R&D



## NOTE

L'articolo non prevede la fornitura delle parti in legno.  
The item does not include the supply of wooden parts.

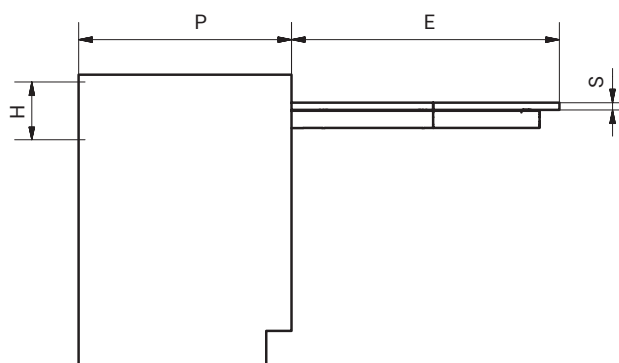
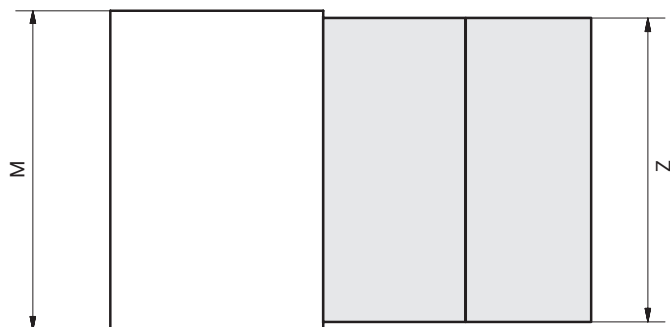

CODICE CODE	M	P min	H min	S1	E	Z min	S min	SILENT
411/78.1155.22 E	450	540	120	15/20	753	405	16	78.1155.22 E
411/78.1150.22 E	600	540	120	15/20	753	555	16	78.1150.22 E
411/78.1160.22 E	900	540	120	15/20	753	855	16	78.1160.22 E
411/78.1170.22 E	1200	540	120	15/20	753	1155	16	78.1170.22 E

Valori espressi in millimetri. Value expressed in millimetres.

Legenda tabella e riferimenti optional a pagina 118. Key to table and optional references on page 118





# Lunch

TAVOLO ESTRAIBILE DA CASSETTO  
PULL-OUT DRAWER TABLE

## DESIGN

Arch. Giulio Manzoni  
ATIM R&S / ATIM R&D

### FINITURA

#### FINISHING

Inox Bronzino

### PORTATA

#### LOAD CAPACITY

60 Kg equamente distribuiti

60 Kg evenly distributed

### PACKAGING

118x18x8 cm

5 Kg

0,017 m<sup>3</sup>

### SCORRIMENTO

#### SLIDING

Alluminio / Alluminio

Aluminium / Aluminium

### OPTIONAL

su richiesta / on request

### KIT TAPPI

#### KIT CAPS

2.9247231.XX

### PIANO

#### TOP TABLE

Truciolare bianco

White chipboard

Lunch 600 3.9129876.12 M

Lunch 900 3.9129866.12 M

### CERNIERE

#### HINGES

2.8029912.12

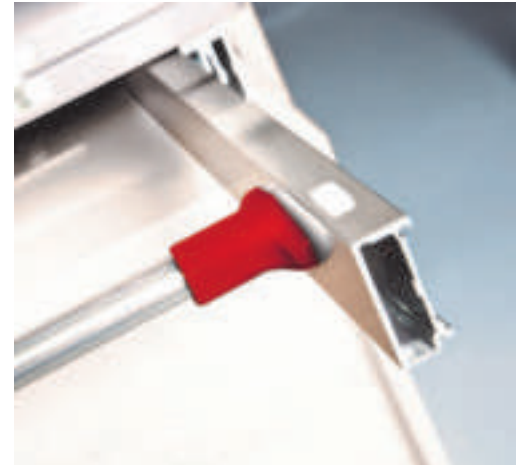

#### NOTE

L'articolo non prevede la fornitura delle parti in legno.  
The item does not include the supply of wooden parts.

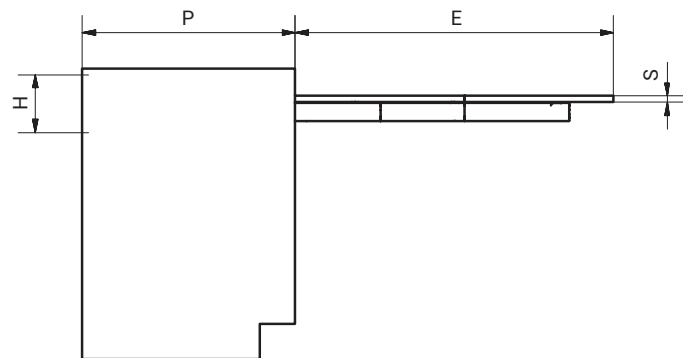
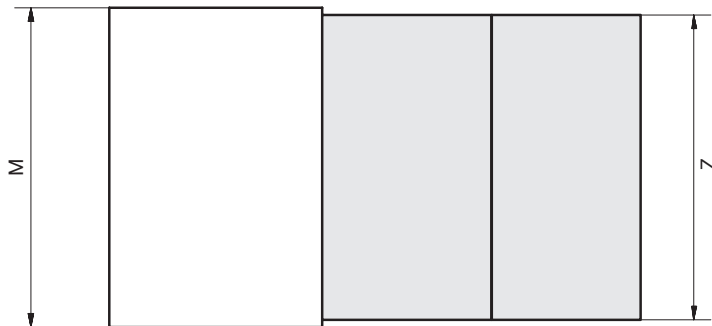

CODICE CODE	M	P min	H min	S1	E	Z min	S min	SILENT
411/78.1105.22 E	450	540	120	15/20	895	405	16	78.1105.22 E
411/78.1100.22 E	600	540	120	15/20	895	555	16	78.1100.22 E
411/78.1110.22 E	900	540	120	15/20	895	855	16	78.1110.22 E
411/78.1120.22 E	1200	540	120	15/20	895	1155	16	78.1120.22 E

Valori espressi in millimetri. Value expressed in millimetres.

Legenda tabella e riferimenti optional a pagina 118. Key to table and optional references on page 118



# Lunch Reverse

TAVOLO ESTRAIBILE DA CASSETTO  
PULL-OUT DRAWER TABLE

## FINITURA

### FINISHING

Inox Bronzino

## PORTATA

### LOAD CAPACITY

60 Kg equamente distribuiti

60 Kg evenly distributed

## PACKAGING

118x18x8 cm

4,5 Kg

0,017 m<sup>3</sup>

## SCORRIMENTO

### SLIDING

Alluminio / Alluminio

Aluminium / Aluminium

## OPTIONAL

su richiesta / on request

## KIT TAPPI

### KIT CAPS

2.9247231.XX

## CERNIERE

### HINGES

2.8029912.12

## DESIGN

Arch. Giulio Manzoni

ATIM R&S / ATIM R&D



## NOTE

L'articolo non prevede la fornitura delle parti in legno.  
The item does not include the supply of wooden parts.

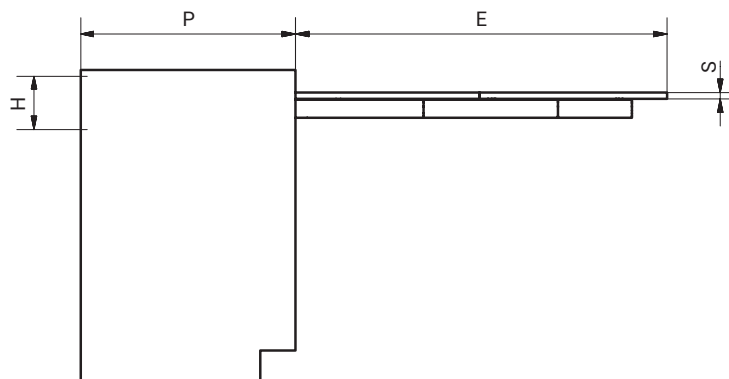
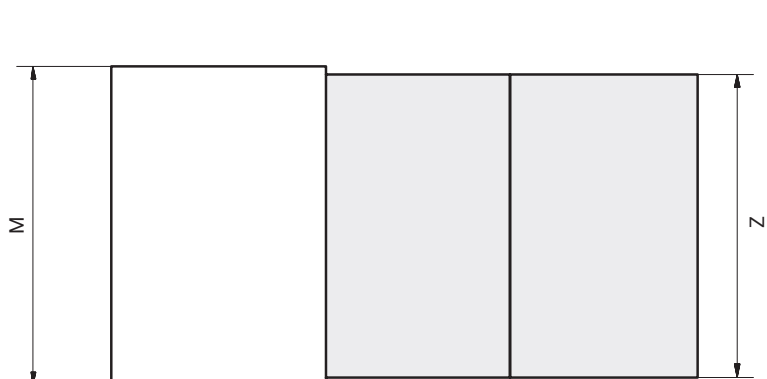

CODICE CODE	M	P min	H min	S1	E	Z	S min	SILENT
411/78.1100.25 R	450/1200	540	120	15/20	1045	405/1155	16	78.1100.25 R

Valori espressi in millimetri. Value expressed in millimetres.

Legenda tabella e riferimenti optional a pagina 118. Key to table and optional references on page 118



# Ready

TAVOLO ESTRAIBILE DA CASSETTO CON  
SISTEMA SINCRONO: APERTO/CHIUSO  
*PULL-OUT DRAWER TABLE WITH  
SYNCHRONOUS SYSTEM: OPEN/CLOSE*

## FINITURA

### FINISHING

Inox Bronzino

## PORTATA

### LOAD CAPACITY

60 Kg equamente distribuiti

*60 Kg evenly distributed*

## PACKAGING

118x18x8 cm

5 Kg

0,017 m<sup>3</sup>

## SCORRIMENTO

### SLIDING

Alluminio / Alluminio

*Aluminium / Aluminium*

## OPTIONAL

su richiesta / *on request*

## KIT TAPPI

### KIT CAPS

2.9247231.XX

## DESIGN

Arch. Giulio Manzoni

ATIM R&S / ATIM R&D



## NOTE

L'articolo non prevede la fornitura delle parti in legno.  
*The item does not include the supply of wooden parts.*

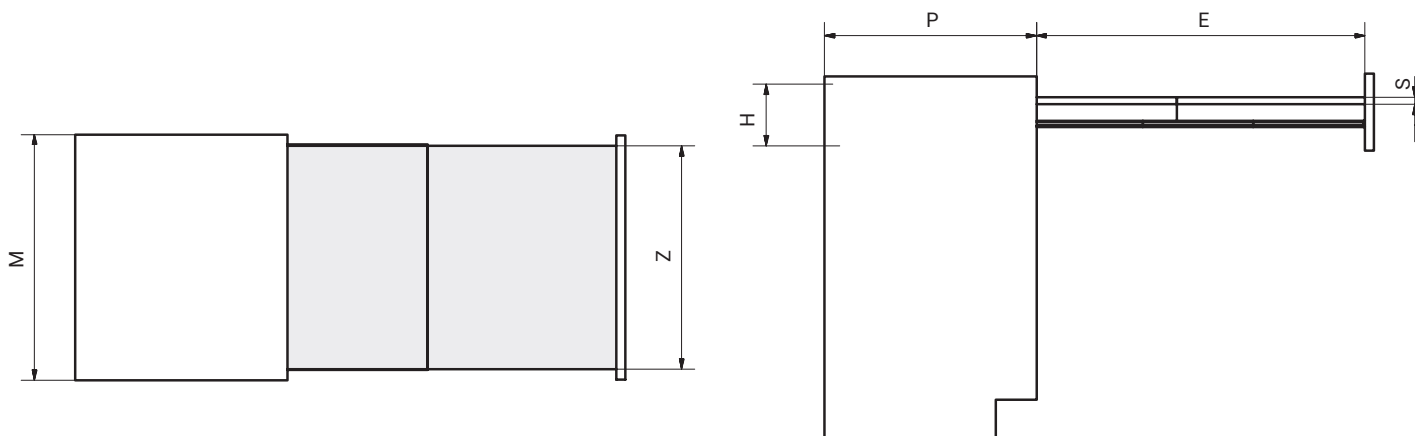

CODICE CODE	M	P min	H min	S1	E	Z min	S	SILENT
411/78.1140.25	450	490	150	15/20	800	390	16/18	78.1140.25
411/78.1141.25	600	490	150	15/20	800	540	16/18	78.1141.25
411/78.1142.25	900	490	150	15/20	800	840	16/18	78.1142.25

Valori espressi in millimetri. *Value expressed in millimetres.*

Legenda tabella e riferimenti optional a pagina 118. *Key to table and optional references on page 118*



# Oplà

PIANO ESTRAIBILE FILO RIPIANO  
PULL-OUT TOP ALLIGNED WITH SHELF

## DESIGN

Arch. Giulio Manzoni  
ATIM R&S / ATIM R&D

### FINITURA

#### FINISHING

Inox Bronzino

### PORTATA

#### LOAD CAPACITY

40 Kg equamente distribuiti

40 Kg evenly distributed

### PACKAGING

118x18x8 cm

4,4 Kg

0,017 m<sup>3</sup>

### SCORRIMENTO

#### SLIDING

Alluminio / Alluminio

Aluminium / Aluminium

### OPTIONAL

su richiesta / on request

### KIT TAPPI

#### KIT CAPS

2.9247221.XX



#### NOTE

L'articolo non prevede la fornitura delle parti in legno.  
The item does not include the supply of wooden parts.

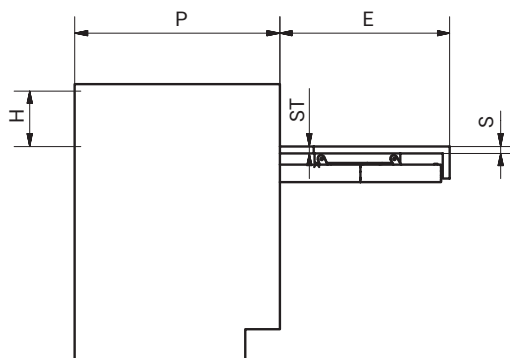
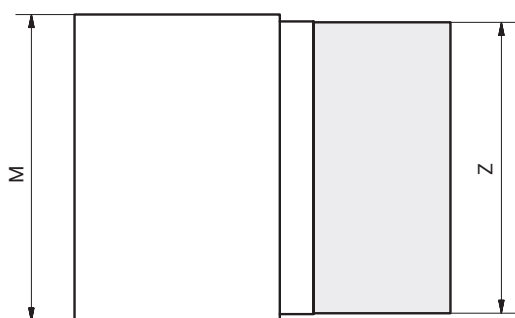

CODICE CODE	M	P min	H min	S1	E	Z min	S	ST	SILENT
411/78.1700.22	450	540	75	15/20	500	405	15/20	15/20	78.1700.22
411/78.1710.22	600	540	75	15/20	500	555	15/20	15/20	78.1710.22
411/78.1720.22	900	540	75	15/20	500	855	15/20	15/20	78.1720.22
411/78.1730.22	1200	540	75	15/20	500	1155	15/20	15/20	78.1730.22

Valori espressi in millimetri. Value expressed in millimetres.

Legenda tabella e riferimenti optional a pagina 118. Key to table and optional references on page 118





# Oplà Piano Acciaio

PIANO ESTRAIBILE FILO RIPIANO  
PULL-OUT TOP ALLIGNED WITH SHELF

## DESIGN

Arch. Giulio Manzoni  
ATIM R&S / ATIM R&D

### FINITURA

#### FINISHING

Inox Bronzino

### PORTATA

#### LOAD CAPACITY

40 Kg equamente distribuiti

40 Kg evenly distributed

### PACKAGING

#### 411/78.1700.AC

60x57x16 cm 9 Kg 0,05 m<sup>3</sup>

#### 411/78.1710.AC

90x57x16 cm 25,5 Kg 0,08 m<sup>3</sup>

#### 411/78.1720.AC

120x57x16 cm 32 Kg 0,10 m<sup>3</sup>

### SCORRIMENTO

#### SLIDING

Alluminio / Alluminio

Aluminium / Aluminium

### OPTIONAL

su richiesta / on request

### KIT TAPPI

#### KIT CAPS

2.9247221.XX



#### NOTE

L'articolo prevede la fornitura di piani in acciaio inox AISI A430.  
The article includes the supply of AISI A430 stainless steel tops.

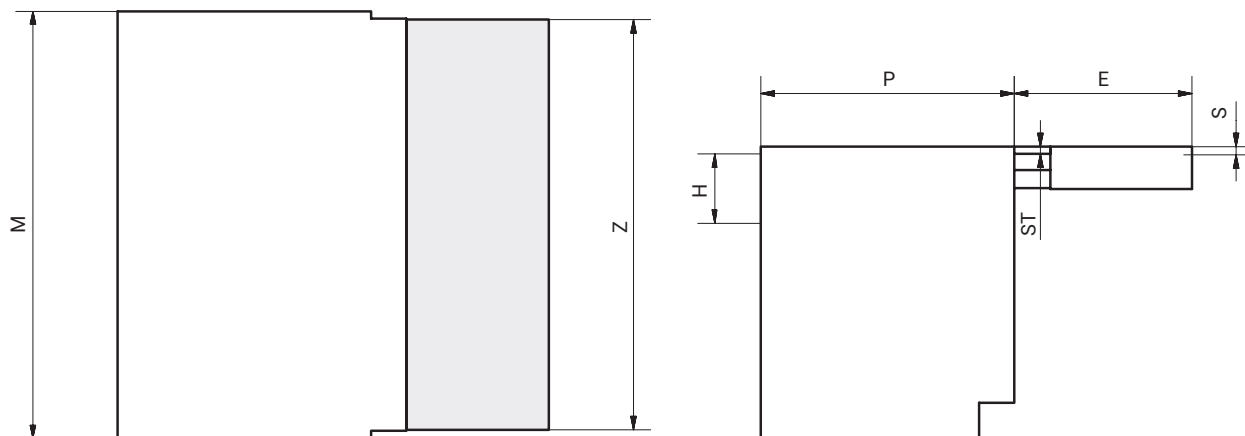

CODICE CODE	M	P min	H min	S1	E	Z min	S	ST
411/78.1700.AC	600	505	120	18	450	564	19	19
411/78.1710.AC	900	505	120	18	450	864	19	19
411/78.1720.AC	1200	505	120	18	450	1164	19	19

Valori espressi in millimetri. Value expressed in millimetres.

Legenda tabella e riferimenti optional a pagina 118. Key to table and optional references on page 118



# Oplà Folding / Oplà Folding Small

## DESIGN

Arch. Giulio Manzoni  
ATIM R&S / ATIM R&D

PIANO ESTRAIBILE FILO RIPIANO  
PULL-OUT TOP ALLIGNED WITH SHELF

### FINITURA

#### FINISHING

Inox Bronzino

### PORTATA

#### LOAD CAPACITY

40 Kg equamente distribuiti

40 Kg evenly distributed

### PACKAGING

118x18x8 cm

7 Kg

0,017 m<sup>3</sup>

### SCORRIMENTO

#### SLIDING

Alluminio / Alluminio

Aluminium / Aluminium

### OPTIONAL

su richiesta / on request

### KIT TAPPI

#### KIT CAPS

2.9247221.XX



#### NOTE

L'articolo non prevede la fornitura delle parti in legno.  
The item does not include the supply of wooden parts.

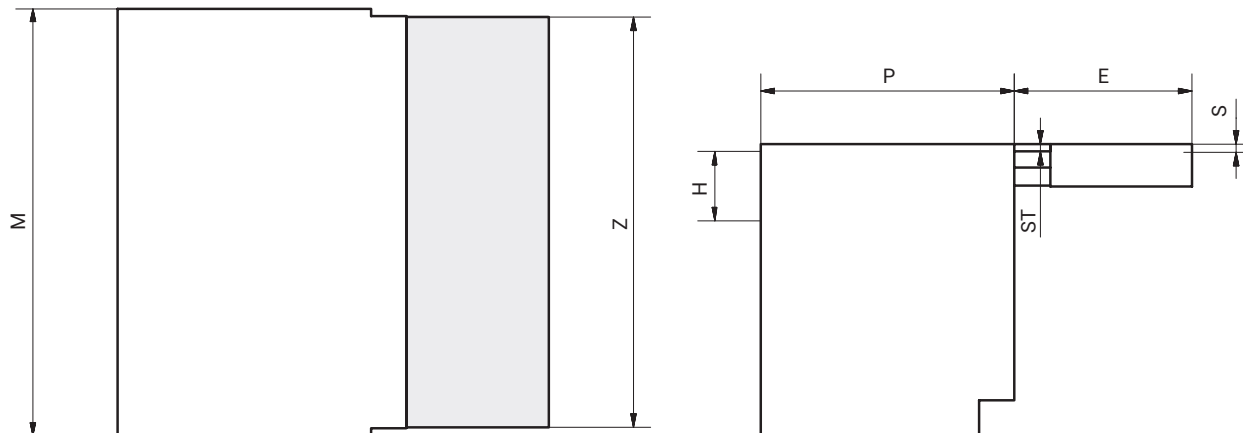

## Oplà Folding

CODICE CODE	M	P min	H min	S1	E	Z min	S	ST
78.1700.25 F	600	540	220	18	500	555	18	15/35
78.1710.25 F	900	540	220	18	500	855	18	15/35
78.1720.25 F	1200	540	220	18	500	1155	18	15/35

Valori espressi in millimetri. Value expressed in millimetres.

Legenda tabella e riferimenti optional a pagina 118. Key to table and optional references on page 118



## Oplà Folding Small

CODICE CODE	M	P min	H min	S1	E	Z min	S	ST
78.1700.25 FS	600	540	125	18	500	550	18	15/35
78.1710.25 FS	900	540	125	18	500	850	18	15/35
78.1720.25 FS	1200	540	125	18	500	1150	18	15/35

Valori espressi in millimetri. Value expressed in millimetres.

Legenda tabella e riferimenti optional a pagina 118. Key to table and optional references on page 118

# Shot

PIANO ESTRAIBILE DA CASSETTO  
PULL-OUT DRAWER WORKTOP

## DESIGN

Arch. Giulio Manzoni  
ATIM R&S / ATIM R&D

### FINITURA

#### FINISHING

Inox Bronzino

### PORTATA

#### LOAD CAPACITY

80 Kg equamente distribuiti

80 Kg evenly distributed

### PACKAGING

118x18x8 cm

4 Kg

0,017 m<sup>3</sup>

### SCORRIMENTO

#### SLIDING

Alluminio / Alluminio

Aluminium / Aluminium

### OPTIONAL

su richiesta / on request

### KIT TAPPI

#### KIT CAPS

2.9247221.XX

### NOTE

L'articolo non prevede la fornitura delle parti in legno.  
The item does not include the supply of wooden parts.

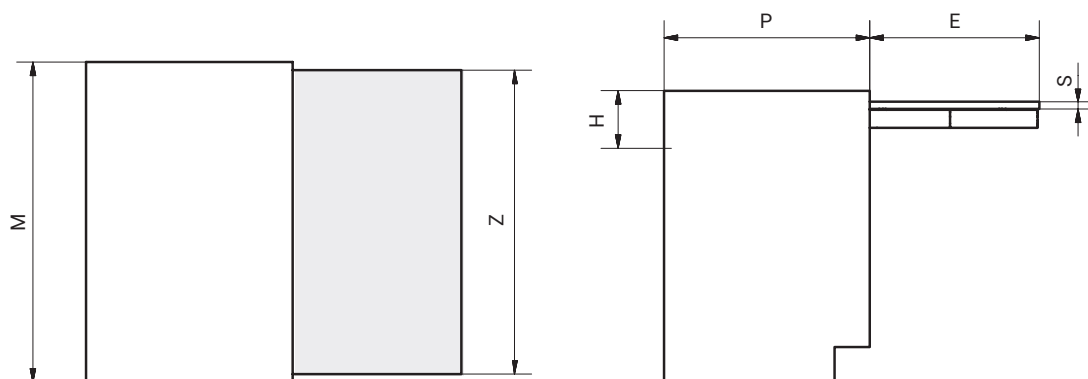

CODICE CODE	M	P min	H min	S1	E	Z	S min	SILENT
411/78.1130.25	410/1200	560	90	15/20	480	405/1155	16	78.1130.25

Valori espressi in millimetri. Value expressed in millimetres.

Legenda tabella e riferimenti optional a pagina 118. Key to table and optional references on page 118



# Shot Folding

PIANO ESTRAIBILE DA CASSETTO  
PULL-OUT DRAWER WORKTOP

## DESIGN

Arch. Giulio Manzoni  
ATIM R&S / ATIM R&D

### FINITURA

#### FINISHING

Inox Bronzino

### PORTATA

#### LOAD CAPACITY

80 Kg equamente distribuiti

80 Kg evenly distributed

### PACKAGING

118x18x8 cm

4 Kg

0,017 m<sup>3</sup>

### SCORRIMENTO

#### SLIDING

Alluminio / Alluminio

Aluminium / Aluminium

### OPTIONAL

su richiesta / on request

### KIT TAPPI

#### KIT CAPS

2.9247221.XX



#### NOTE

L'articolo non prevede la fornitura delle parti in legno.  
The item does not include the supply of wooden parts.

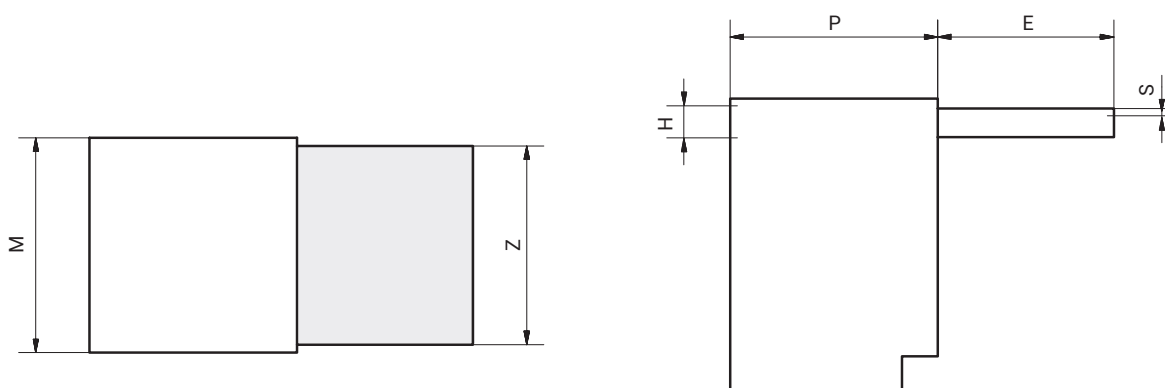

CODICE CODE	M	P min	H min	S1	E	Z	S min	SILENT
411/78.1130.25 F	410/1200	560	90	15/20	480	405/1155	16	78.1130.25 F

Valori espressi in millimetri. Value expressed in millimetres.

Legenda tabella e riferimenti optional a pagina 118. Key to table and optional references on page 118





# Desk

SCRIVANIA ABBATTIBILE A RIBALTA  
DROP-LEAF FOLDAWAY DESK

## DESIGN

Arch. Giulio Manzoni  
ATIM R&S / ATIM R&D

### FINITURA

#### FINISHING

Ferro zincato  
Galvanised iron

### PORTATA

#### LOAD CAPACITY

20 Kg equamente distribuiti  
20 Kg evenly distributed

### PACKAGING

35x18x6 cm  
3,1 Kg  
0,003 m<sup>3</sup>

### OPTIONAL

su richiesta / on request

### COVER

Nero  
Black  
2.5541204.10

Bianco  
White  
2.5541204.12



### NOTE

L'articolo non prevede la fornitura delle parti in legno.  
The item does not include the supply of wooden parts.

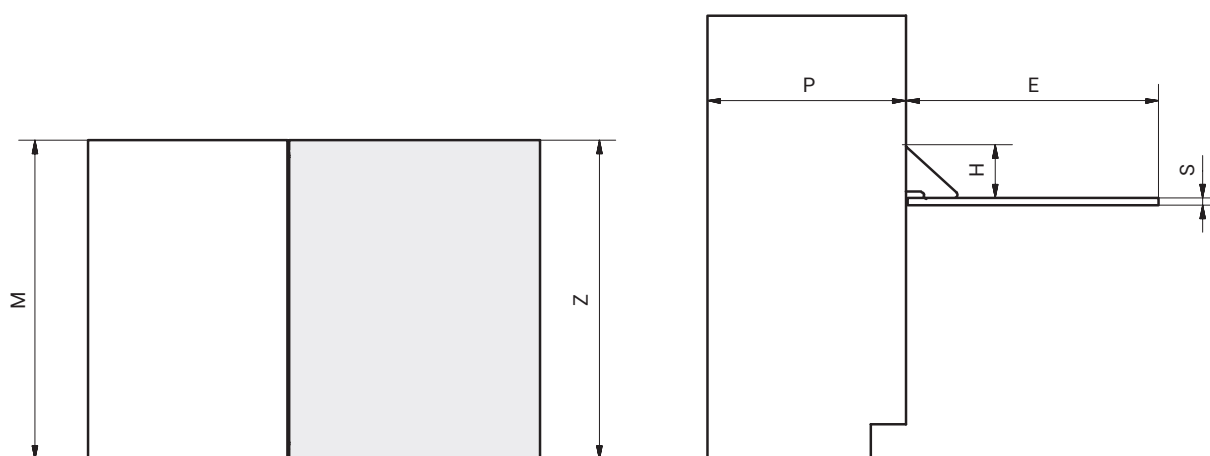

CODICE CODE	M min	P min	H min	S1	E min	Z min	S min
411/78.0005.02	450	150	200	15/20	350	445	18

Valori espressi in millimetri. Value expressed in millimetres.

Legenda tabella e riferimenti optional a pagina 118. Key to table and optional references on page 118



# Homework

TAVOLO ABBATTIBILE A SOFFIETTO  
FOLD-OUT TABLE

## FINITURA

### FINISHING

Inox Bronzino

## PORTATA

### LOAD CAPACITY

40 Kg equamente distribuiti

40 Kg evenly distributed

## PACKAGING

118x18x8 cm

4,5 Kg

0,017 m<sup>3</sup>

## SCORRIMENTO

### SLIDING

Alluminio / Alluminio

Aluminium / Aluminium

## OPTIONAL

su richiesta / on request

## KIT TAPPI

### KIT CAPS

2.9247231.XX

## KIT HOMEWORK

Cerniere + Push Pull

Hinges + Push Pull

2.9248320.XX

## DESIGN

Arch. Giulio Manzoni

ATIM R&S / ATIM R&D



## NOTE

L'articolo non prevede la fornitura delle parti in legno.  
The item does not include the supply of wooden parts.

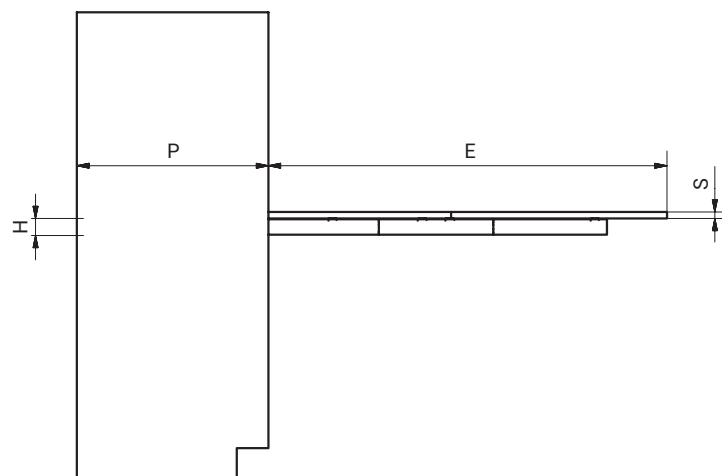
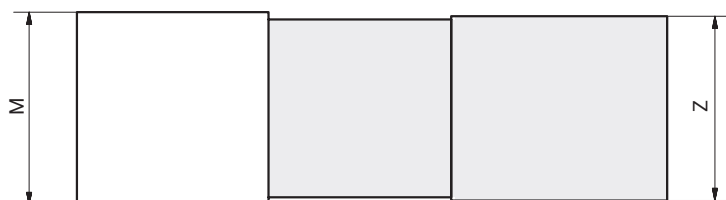

CODICE CODE	M	P min	H min	S1	E	Z min	S min	SILENT
411/78.1200.22	600	540	54	15/20	1120	575	16	78.1200.22
411/78.1210.22	900	540	54	15/20	1120	875	16	78.1210.22
411/78.1220.22	1200	540	54	15/20	1120	1175	16	78.1220.22

Valori espressi in millimetri. Value expressed in millimetres.

Legenda tabella e riferimenti optional a pagina 118. Key to table and optional references on page 118



# Universal

PIANO ESTRAIBILE DA COLONNA  
PULL-OUT COLUMN WORKTOP

## DESIGN

Arch. Giulio Manzoni  
ATIM R&S / ATIM R&D

### FINITURA

#### FINISHING

Inox Bronzino

### PORTATA

#### LOAD CAPACITY

80 Kg equamente distribuiti

80 Kg evenly distributed

### PACKAGING

118x18x8 cm

4 Kg

0,017 m<sup>3</sup>

### SCORRIMENTO

#### SLIDING

Alluminio / Alluminio

Aluminium / Aluminium

### OPTIONAL

su richiesta / on request

### KIT TAPPI

#### KIT CAPS

2.9247221.XX



#### NOTE

L'articolo non prevede la fornitura delle parti in legno.  
The item does not include the supply of wooden parts..

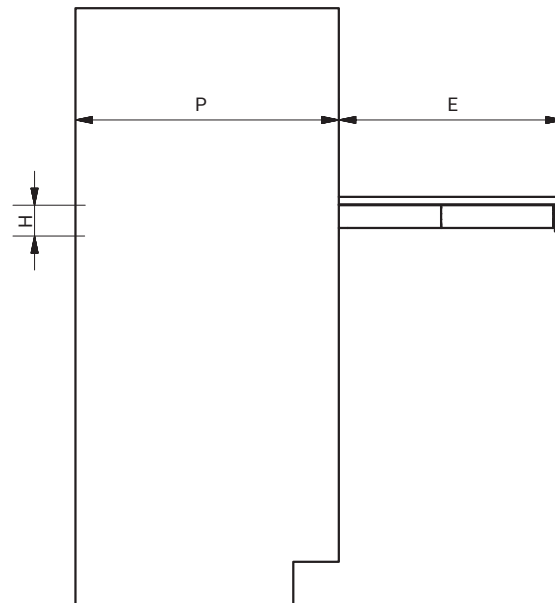
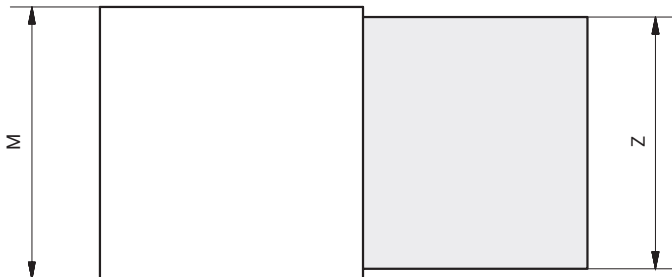

CODICE CODE	M	P min	H min	S1	E	Z	S min	SILENT
411/78.1499.25	450/1200	560	90	15/20	490	405/1155	16	78.1499.25

Valori espressi in millimetri. Value expressed in millimetres.

Legenda tabella e riferimenti optional a pagina 118. Key to table and optional references on page 118



# Universal Box

PIANO CON CONTENITORE  
ESTRAIBILE DA COLONNA  
*PULL-OUT COLUMN TOP  
WITH CUTLERY TRAY*

## FINITURA

### FINISHING

Inox Bronzino

## PORTATA

### LOAD CAPACITY

60 Kg equamente distribuiti

*60 Kg evenly distributed*

## PACKAGING (3 packages)

### 78.1495.25

Guide *Slides*

118x18x8 cm 4 Kg 0,017 m<sup>3</sup>

Piani *Tops*

56x45x3 cm 4 Kg 0,007 m<sup>3</sup>

Vasca *Tray*

50x36x6 cm 2,5 Kg 0,010 m<sup>3</sup>

### 78.1496.25

Guide *Slides*

118x18x8 cm 4 Kg 0,017 m<sup>3</sup>

Piani *Tops*

86x44x3 cm 6 Kg 0,011 m<sup>3</sup>

Vasca *Tray*

80x36x6 cm 4 Kg 0,017 m<sup>3</sup>

## SCORRIMENTO

### SLIDING

Alluminio / Alluminio

*Aluminium / Aluminium*

## PIANO / CONTENITORE

### TOP / TRAY

Faggio

*Beech-Wood*

## DESIGN

Arch. Giulio Manzoni

ATIM R&S / ATIM R&D

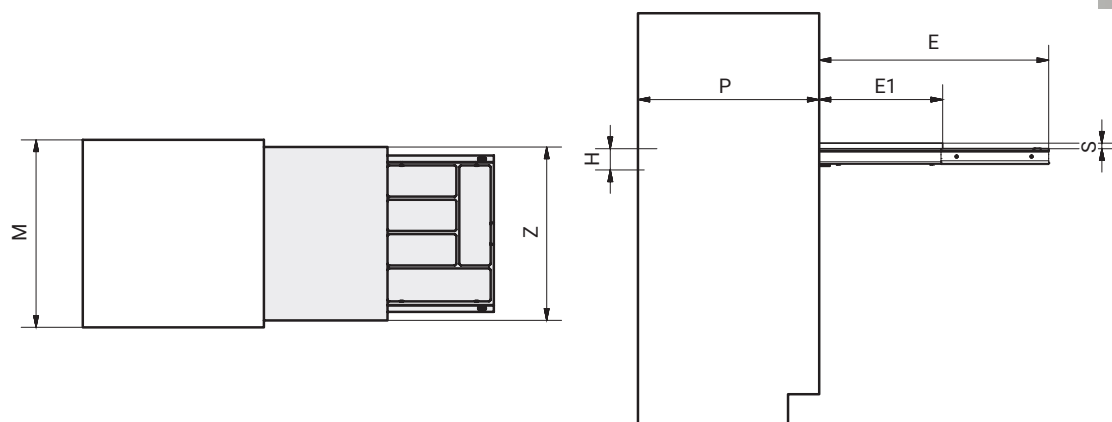

CODICE CODE	M	P min	H min	S1	E1	E	Z	S min
78.1495.25	600	520	120	16/19	400	740	555	18
78.1496.25	900	520	120	16/19	400	740	855	18

Valori espressi in millimetri. Value expressed in millimetres.

Legenda tabella e riferimenti optional a pagina 118. Key to table and optional references on page 118





# Functional

PIANO CON CONTENITORE  
ESTRAIBILE DA CASSETTO  
*PULL-OUT DRAWER WORKTOP  
WITH CUTLERY TRAY*

## FINITURA

### FINISHING

Inox Bronzino

## PORTATA

### LOAD CAPACITY

40 Kg equamente distribuiti

40 Kg evenly distributed

## PACKAGING (3 packages)

### 78.1493.25

Guide *Slides*

118x18x8 cm 4 Kg 0,017 m<sup>3</sup>

Piani *Tops*

60x38x6 cm 4,5 Kg 0,014 m<sup>3</sup>

Vasca *Tray*

50x36x6 cm 2,5 Kg 0,010 m<sup>3</sup>

### 78.1494.25

Guide *Slides*

118x18x8 cm 4 Kg 0,017 m<sup>3</sup>

Piani *Tops*

94x36x6 cm 7 Kg 0,020 m<sup>3</sup>

Vasca *Tray*

80x36x6 cm 4 Kg 0,017 m<sup>3</sup>

## SCORRIMENTO

### SLIDING

Alluminio / Alluminio

Aluminium / Aluminium

## PIANO / CONTENITORE

### TOP / TRAY

Faggio

Beech-Wood

## DESIGN

Arch. Giulio Manzoni

ATIM R&S / ATIM R&D

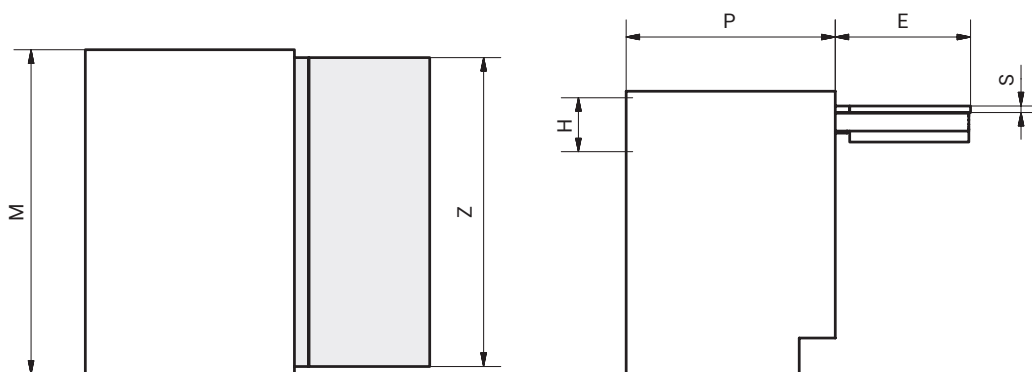

CODICE CODE	M	P min	H min	S1	E	Z min	S min
78.1493.25	600	540	110	16/19	375	555	16
78.1494.25	900	540	110	16/19	375	855	16

Valori espressi in millimetri. Value expressed in millimetres.

Legenda tabella e riferimenti optional a pagina 118. Key to table and optional references on page 118



# Blade

TAGLIERE CON CONTENITORE  
ESTRAIBILE DA CASSETTO  
*PULL-OUT CHOPPING BOARD  
WITH CUTLERY TRAY*

## FINITURA

### FINISHING

Inox Bronzino

## PORTATA

### LOAD CAPACITY

60 Kg equamente distribuiti

*60 Kg evenly distributed*

## PACKAGING (4 packages)

Guide *Slides*

118x18x8 cm 4 Kg 0,017 m<sup>3</sup>

Piani *Tops*

60x60x6 cm 8 Kg 0,021 m<sup>3</sup>

Vasca *Tray*

50x36x6 cm 2,5 Kg 0,010 m<sup>3</sup>

Cesto *Basket*

13x14x15 cm 0,5 Kg 0,002 m<sup>3</sup>

## SCORRIMENTO

### SLIDING

Alluminio / Alluminio

*Aluminium / Aluminium*

## PIANO / CONTENITORE

### TOP / TRAY

Faggio

*Beech-Wood*

## CESTO

### BASKET

Alluminio

*Aluminium*

## DESIGN

Arch. Giulio Manzoni

ATIM R&S / ATIM R&D

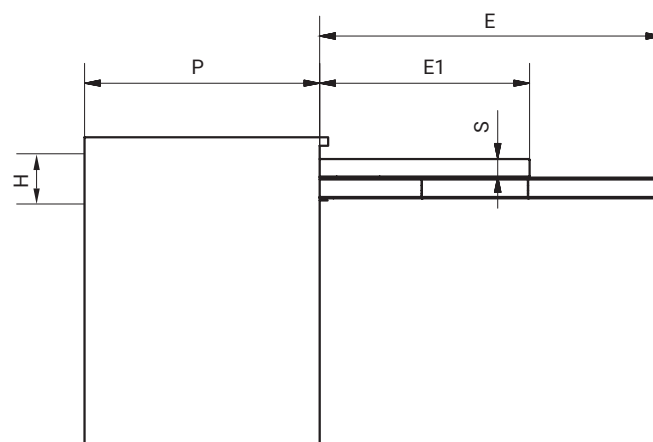
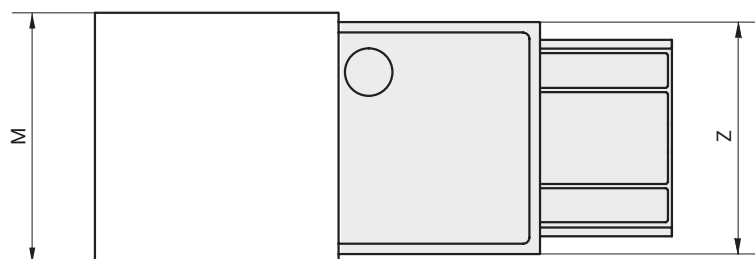

CODICE CODE	M	P min	H min	S1	E1	E	Z	S min
78.1492.25	600	560	120	16/19	500	820	555	40

Valori espressi in millimetri. Value expressed in millimetres.

Legenda tabella e riferimenti optional a pagina 118. Key to table and optional references on page 118



# Cook

TAVOLO CON TAGLIERE E CONTENITORE  
ESTRAIBILE DA CASSETTO  
*PULL-OUT DRAWER TABLE WITH CHOPPING  
BOARD AND CUTLERY TRAY*

## FINITURA

### FINISHING

Inox Bronzino

## PORTATA

### LOAD CAPACITY

60 Kg equamente distribuiti

*60 Kg evenly distributed*

## PACKAGING (4 packages )

### 78.1490.25

Guide *Slides*

118x18x8 cm 4 Kg 0,017 m<sup>3</sup>

Piani *Tops*

56x45x6 cm 8,5 Kg 0,015 m<sup>3</sup>

Vasca *Tray*

50x36x6 cm 2,5 Kg 0,010 m<sup>3</sup>

Cesto *Basket*

13x14x15 cm 0,5 Kg 0,002 m<sup>3</sup>

### 78.1491.25

Guide *Slides*

118x18x8 cm 4 Kg 0,017 m<sup>3</sup>

Piani *Tops*

86x44x6 cm 12,5 Kg 0,022 m<sup>3</sup>

Vasca *Tray*

80x36x6 cm 4 Kg 0,017 m<sup>3</sup>

Cesto *Basket*

13x14x15 cm 0,5 Kg 0,002 m<sup>3</sup>

## PIANO E CONTENITORE

### TOP AND TRAY

Faggio

*Beech-Wood*

## CESTO

### BASKET

Alluminio

*Aluminium*

## SCORRIMENTO

### SLIDING

Alluminio / Alluminio

*Aluminium / Aluminium*

## DESIGN

Arch. Giulio Manzoni

ATIM R&S / ATIM R&D

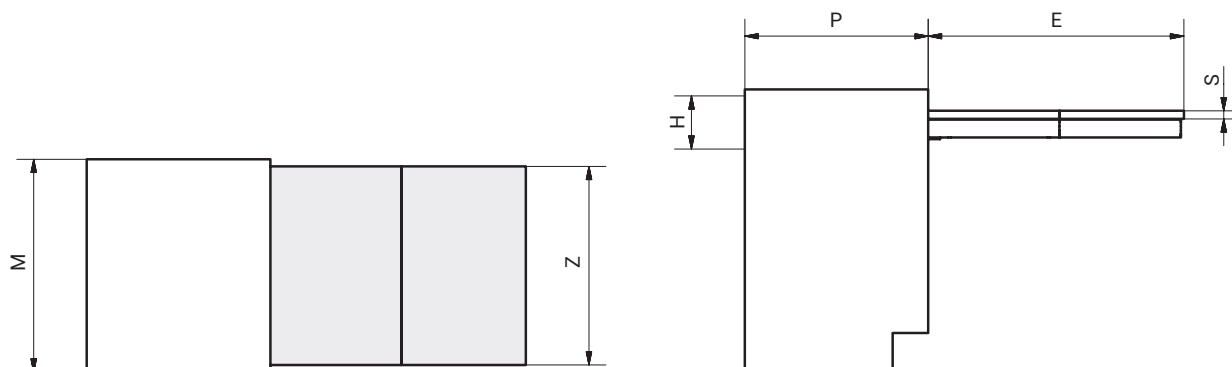

CODICE CODE	M	P min	H min	S1	E	Z	S min
78.1490.25	600	520	120	16/19	740	550	18
78.1491.25	900	520	120	16/19	740	850	18

Valori espressi in millimetri. Value expressed in millimetres.

Legenda tabella e riferimenti optional a pagina 118. Key to table and optional references on page 118



# T-Able / T-Able XL

TAVOLO CON GAMBA SINGOLA ABBATTIBILE  
TELESCOPICA ESTRAIBILE DA CASSETTO  
PULL-OUT DRAWER TABLE  
WITH SINGLE TELESCOPIC FOLDING LEG

## DESIGN

Arch. Giulio Manzoni  
ATIM R&S / ATIM R&D

### FINITURA

#### FINISHING

Inox Bronzino

### PORTATA

#### LOAD CAPACITY

100 Kg equamente distribuiti  
100 Kg evenly distributed

### PACKAGING

#### T-Able

118x18x8 cm

7,5 Kg

0,017 m<sup>3</sup>

#### T-Able XL

118x18x8 cm

8 Kg

0,017 m<sup>3</sup>

### SCORRIMENTO

#### SLIDING

Alluminio / Alluminio

Aluminium / Aluminium

### OPTIONAL

su richiesta / on request

### KIT TAPPI

#### KIT CAPS

##### T-Able

2.9247231.XX

##### T-Able XL

2.9247251.XX

### PIANO

#### TABLE TOP

Truciolare bianco

White chipboard

##### T-Able 600

3.9129876.12 M

##### T-Able 900

3.9129866.12 M

### CERNIERE

#### HINGES

2.8029912.12

#### NOTE

L'articolo non prevede la fornitura delle parti in legno.  
The item does not include the supply of wooden parts.

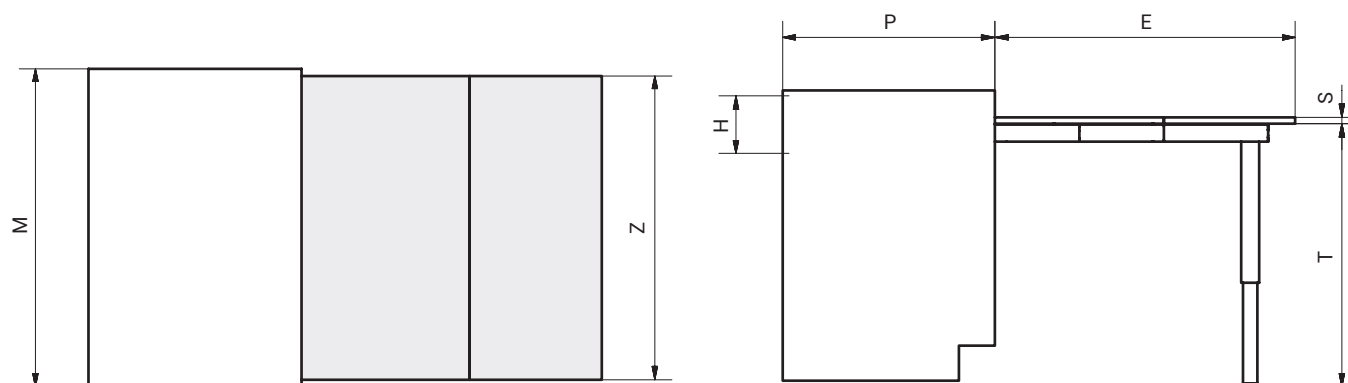

## T-Able

CODICE CODE	M	P min	H min	S1	E	Z min	S min	T	SILENT
411/78.1900.22	600	540	120	15/20	850	555	16	745/840	78.1900.22
411/78.1910.22	900	540	120	15/20	850	855	16	745/840	78.1910.22
411/78.1920.22	1200	540	120	15/20	850	1155	16	745/840	78.1920.22

Valori espressi in millimetri. Value expressed in millimetres.

Legenda tabella e riferimenti optional a pagina 118. Key to table and optional references on page 118



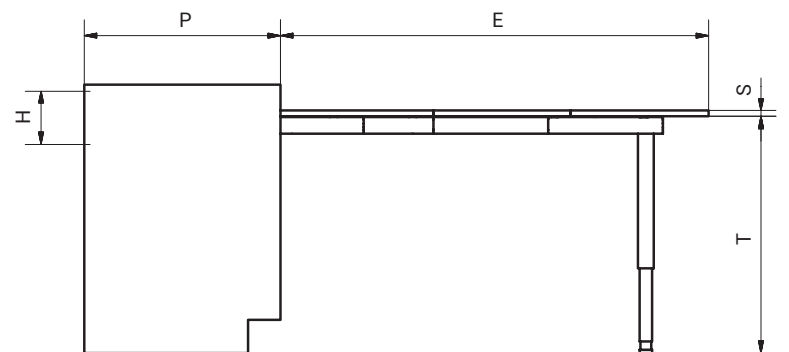
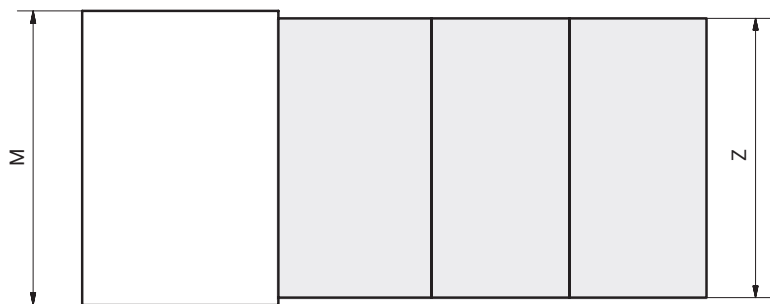

## T-Able XL

CODICE CODE	M	P min	H min	S1	E	Z min	S min	T	SILENT
411/78.1900.22X	600	520	150	15/20	1310	555	16	700/795	78.1900.22X
411/78.1910.22X	900	520	150	15/20	1310	855	16	700/795	78.1910.22X
411/78.1920.22X	1200	520	150	15/20	1310	1155	16	700/795	78.1920.22X

Valori espressi in millimetri. Value expressed in millimetres.

Legenda tabella e riferimenti optional a pagina 118. Key to table and optional references on page 118

# T-Bench / T-Bench XL

SEDUTA CON GAMBA SINGOLA ABBATTIBILE  
ESTRAIBILE DA CASSETTO  
PULL-OUT DRAWER BENCH  
WITH SINGLE FOLDING LEG

## DESIGN

Arch. Giulio Manzoni  
ATIM R&S / ATIM R&D

### FINITURA

#### FINISHING

Inox Bronzino

### PORTATA

#### LOAD CAPACITY

100 Kg equamente distribuiti  
100 Kg evenly distributed

### PACKAGING

#### T-Bench

118x18x8 cm  
6,5 Kg  
0,017 m<sup>3</sup>

#### T-Bench XL

118x18x8 cm  
8 Kg  
0,017 m<sup>3</sup>

### SCORRIMENTO

#### SLIDING

Alluminio / Alluminio  
Aluminium / Aluminium

### OPTIONAL

su richiesta / on request

### KIT TAPPI

#### KIT CAPS

T-Bench  
2.9247231.XX

#### T-Bench XL

2.9247251.XX

### PIANO

#### TABLE TOP

Truciolare bianco  
White chipboard

#### T-Bench 600

3.9129876.12 M

### CERNIERE

#### HINGES

2.8029912.12

#### NOTE

L'articolo non prevede la fornitura delle parti in legno.  
The item does not include the supply of wooden parts.

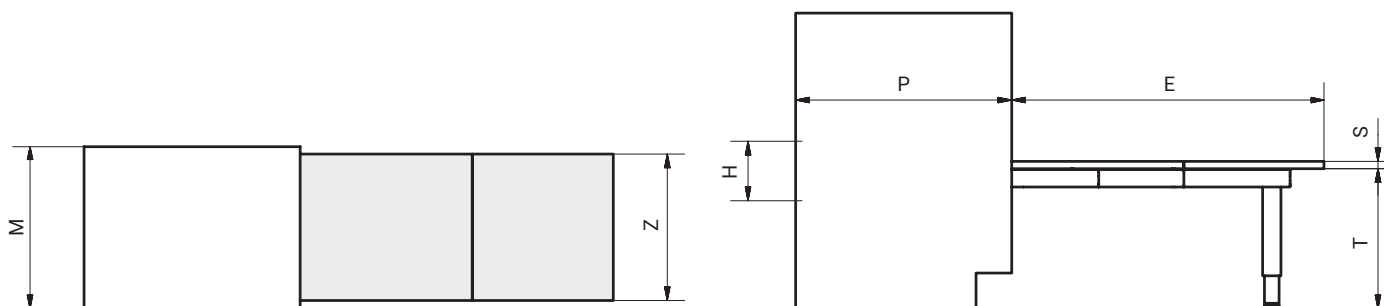

## T-Bench

CODICE CODE	M	P min	H min	S1	E	Z min	S min	T	SILENT
411/78.1950.22	450	540	120	15/20	870	405	16	385/410	78.1950.22
411/78.1960.22	600	540	120	15/20	870	555	16	385/410	78.1960.22

Valori espressi in millimetri. Value expressed in millimetres.

Legenda tabella e riferimenti optional a pagina 118. Key to table and optional references on page 118

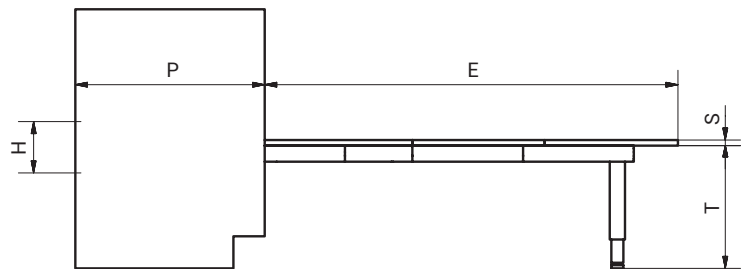

## T-Bench XL

CODICE CODE	M	P min	H min	S1	E	Z min	S min	T	SILENT
411/78.1960.22X	600	520	150	15/20	1310	555	16	385/410	78.1960.22X

Valori espressi in millimetri. Value expressed in millimetres.

Legenda tabella e riferimenti optional a pagina 118. Key to table and optional references on page 118

# Just

PIANO A RIBALTA CON GAMBA SINGOLA  
ABBATTIBILE TELESCOPICA  
TILTING TOP WITH SINGLE TELESCOPIC  
FOLDING LEG

## FINITURA

### FINISHING

Inox Bronzino

## PORTATA

### LOAD CAPACITY

100 Kg equamente distribuiti

100 Kg evenly distributed

## PACKAGING

118x18x8 cm

4 Kg

0,017 m<sup>3</sup>

## SCORRIMENTO

### SLIDING

Alluminio / Alluminio

Aluminium / Aluminium

## DESIGN

ATIM R&S / ATIM R&D

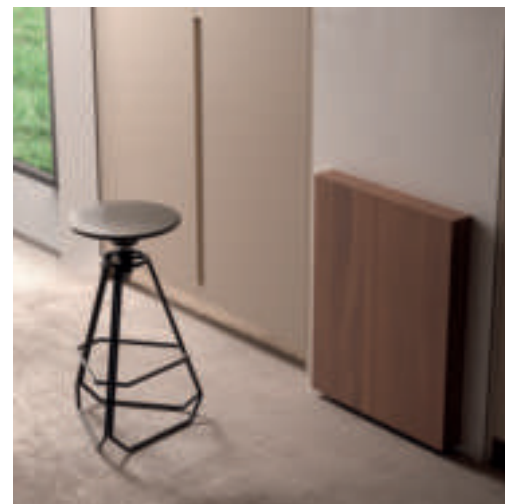

### NOTE

L'articolo non prevede la fornitura delle parti in legno e di componenti per il fissaggio a parete.

The item does not include the supply of wooden parts and components for fixing it to the wall.

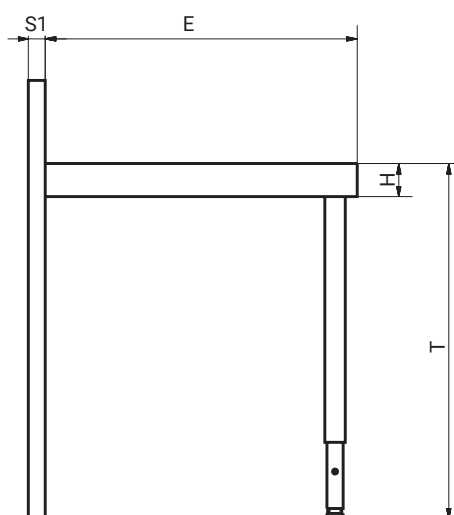
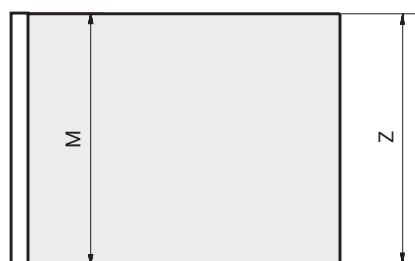

CODICE CODE	M	H min	T	S1 min	E	Z min	S min
411/78.1990.25	600	80	840/860	40	750	600	18
411/78.1990.25P	600	80	840/860	40	750	600	18

Valori espressi in millimetri. Value expressed in millimetres.

Legenda tabella e riferimenti optional a pagina 118. Key to table and optional references on page 118



# Party

TAVOLO CON GAMBA DOPPIA ABBATTIBILE  
TELESCOPICA ESTRAIBILE DA CASSETTO  
*PULL-OUT DRAWER TABLE  
WITH DOUBLE TELESCOPIC FOLDING LEG*

## FINITURA

### FINISHING

Inox Bronzino

## PORTATA

### LOAD CAPACITY

100 Kg equamente distribuiti

*100 Kg evenly distributed*

## PACKAGING

118x18x8 cm

12 Kg

0,017 m<sup>3</sup>

## SCORRIMENTO

### SLIDING

Alluminio / Alluminio

*Aluminium / Aluminium*

## OPTIONAL

su richiesta / *on request*

## KIT TAPPI

### KIT CAPS

2.9247251.XX

## PIANO

### TABLE TOP

Truciolare bianco

*White chipboard*

Party 600 2.9136476.12

Party 900 2.9136486.12

## CERNIERE

### HINGES

2.8029912.12

## DESIGN

Arch. Giulio Manzoni

ATIM R&S / ATIM R&D



## NOTE

L'articolo non prevede la fornitura delle parti in legno.  
*The item does not include the supply of wooden parts.*

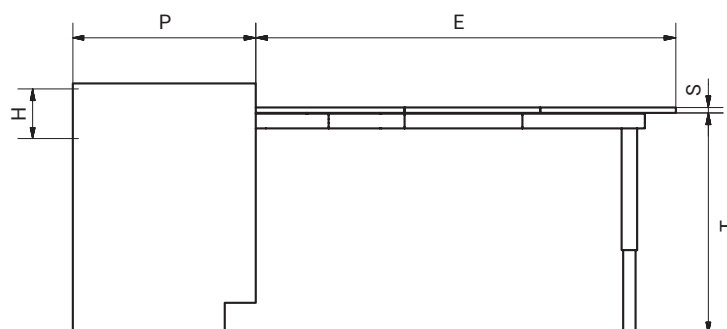
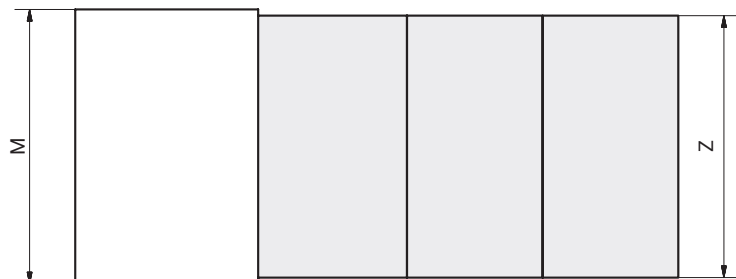

CODICE CODE	M	P min	H min	S1	E	Z min	S min	T	SILENT
411/78.1500.22	600	560	150	16/19	1380	557	16	725/820	78.1500.22
411/78.1510.22	900	560	150	16/19	1380	857	16	725/820	78.1510.22
411/78.1520.22	1200	560	150	16/19	1380	1157	16	725/820	78.1520.22

Valori espressi in millimetri. *Value expressed in millimetres.*

Legenda tabella e riferimenti optional a pagina 118. *Key to table and optional references on page 118*



# Mensola Party

TAVOLO CON GAMBA DOPPIA ABBATTIBILE  
TELESCOPICA ESTRAIBILE DA CASSETTO  
*PULL-OUT DRAWER TABLE  
WITH DOUBLE TELESCOPIC FOLDING LEG*

## FINITURA

### FINISHING

Inox Bronzino

## PORTATA

### LOAD CAPACITY

100 Kg equamente distribuiti

*100 Kg evenly distributed*

## PACKAGING

### 411/78.1601.22

105x34x8 cm 12,5 Kg 0,03 m<sup>3</sup>

### 411/78.1602.22

105x34x8 cm 13,5 Kg 0,03 m<sup>3</sup>

### 411/78.1600.22

105x34x8 cm 14 Kg 0,03 m<sup>3</sup>

## SCORRIMENTO

### SLIDING

Alluminio / Alluminio

*Aluminium / Aluminium*

## OPTIONAL

su richiesta / *on request*

## KIT TAPPI

### KIT CAPS

2.9247281.XX

## DESIGN

Arch. Giulio Manzoni

ATIM R&S / ATIM R&D



## NOTE

L'articolo non prevede la fornitura delle parti in legno e di componenti per il fissaggio a parete.  
*The item does not include the supply of wooden parts and components for fixing it to the wall.*

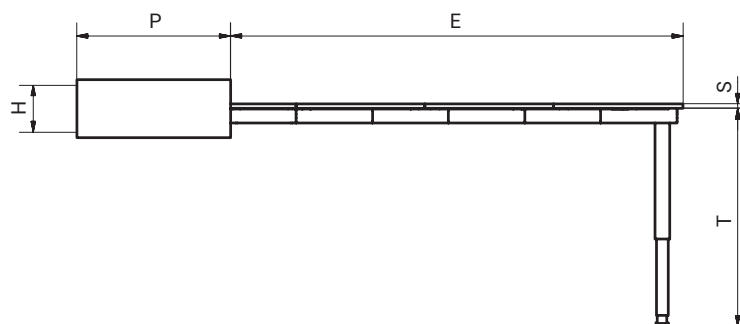
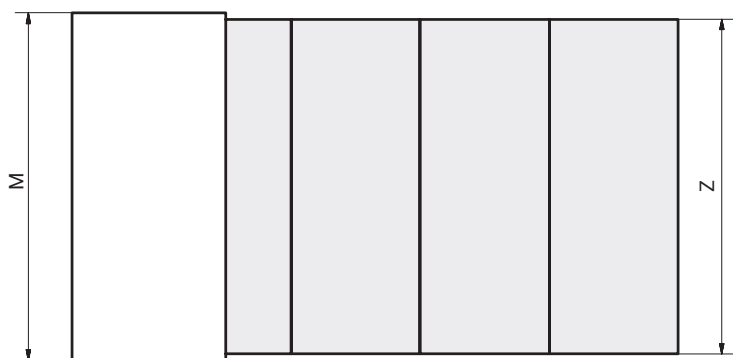

CODICE CODE	M	P min	H min	S1	E	Z min	S	T	SILENT
411/78.1601.22	600	502	140	18,5	1540	555	14	730/755	78.1601.22
411/78.1602.22	900	502	140	18,5	1540	855	14	730/755	78.1602.22
411/78.1600.22	1200	502	140	18,5	1540	1155	14	730/755	78.1600.22

Valori espressi in millimetri. *Value expressed in millimetres.*

Legenda tabella e riferimenti optional a pagina 118. *Key to table and optional references on page 118*





# Evolution / Evolution XL

TAVOLO CON GAMBA A PONTE ESTRAIBILE DA CABINET  
PULL-OUT CABINET TABLE WITH BRIDGE LEG

## DESIGN

Arch. Giulio Manzoni  
ATIM R&S / ATIM R&D

## FINITURA

### FINISHING

Guide / Slides  
Inox Bronzino

Gamba / Leg  
Ral 7012 Grigio / Grey

### Versione / Version Naked (N)

Gamba / Leg  
Ral 9005 Nero opaco / Matt black

## PORTATA

### LOAD CAPACITY

100 Kg equamente distribuiti  
100 Kg evenly distributed

## SCORRIMENTO

### SLIDING

Alluminio / Alluminio  
Aluminium / Aluminium

## PACKAGING (2 packages)

### Evolution / Evolution Naked

411/78.1610.25 411/78.1610.25N  
118x18x8 cm 6 Kg 0,017 m<sup>3</sup>  
57x77x8 cm 8 Kg 0,035 m<sup>3</sup>

### 411/78.1611.25 411/78.1611.25N

118x18x8 cm 6 Kg 0,017 m<sup>3</sup>  
87x88x8 cm 11 Kg 0,055 m<sup>3</sup>

### Evolution XL / Evolution XL Naked

411/78.1620.25 411/78.1620.25N  
118x18x8 cm 8 Kg 0,017 m<sup>3</sup>  
57x77x8 cm 8 Kg 0,035 m<sup>3</sup>

### 411/78.1621.25 411/78.1621.25N

118x18x8 cm 8 Kg 0,017 m<sup>3</sup>  
87x88x8 cm 11 Kg 0,055 m<sup>3</sup>

## OPTIONAL

su richiesta / on request

## KIT TAPPI

### KIT CAPS

Evolution 2.924741.XX

Evolution XL 2.9247271.XX

## CERNIERE

### HINGES

2.8029912.12

## PIANO

### TABLE TOP

Evolution XL 900

3.9141776.12 M

## NOTE

L'articolo non prevede la fornitura delle parti in legno.  
Versione Naked (N): non prevede i traversi per il fissaggio dell'anta.  
The item does not include the supply of wooden parts.  
Naked Version (N): does not include crosspieces for fixing the door.

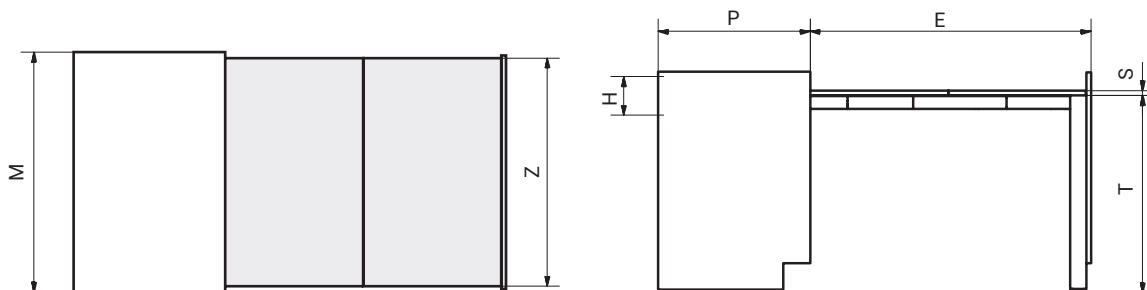

## Evolution

CODICE CODE	M	P min	H min	S1	E	Z min	S min	T	SILENT
411/78.1610.25	600	520	120	15/20	1040	555	16	730/755	78.1610.25
411/78.1611.25	900	520	120	15/20	1040	855	16	730/755	78.1611.25
<b>411/78.1610.25N</b>	<b>600</b>	<b>520</b>	<b>120</b>	<b>15/20</b>	<b>1040</b>	<b>555</b>	<b>16</b>	<b>730/755</b>	<b>78.1610.25N</b>
<b>411/78.1611.25N</b>	<b>900</b>	<b>520</b>	<b>120</b>	<b>15/20</b>	<b>1040</b>	<b>855</b>	<b>16</b>	<b>730/755</b>	<b>78.1611.25N</b>

Valori espressi in millimetri. Value expressed in millimetres.

Legenda tabella e riferimenti optional a pagina 118. Key to table and optional references on page 118

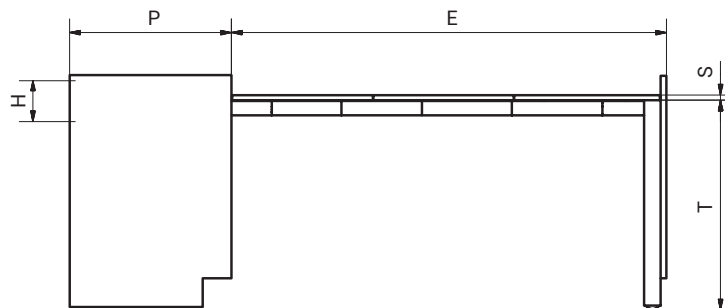
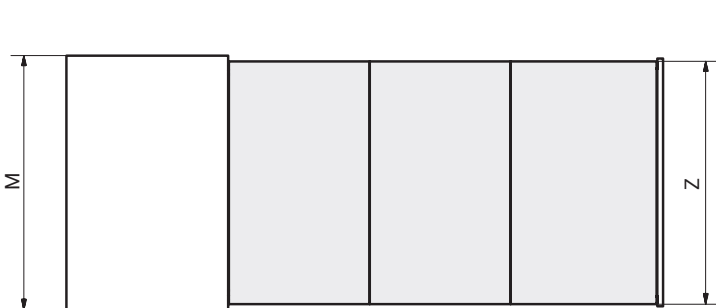

## Evolution XL

<b>CODICE CODE</b>	<b>M</b>	<b>P min</b>	<b>H min</b>	<b>S1</b>	<b>E</b>	<b>Z min</b>	<b>S min</b>	<b>T</b>	<b>SILENT</b>
411/78.1620.25	600	520	150	15/20	1520	555	16	730/755	78.1620.25
411/78.1621.25	900	520	150	15/20	1520	855	16	730/755	78.1621.25
<b>411/78.1620.25N</b>	<b>600</b>	<b>520</b>	<b>150</b>	<b>15/20</b>	<b>1520</b>	<b>555</b>	<b>16</b>	<b>730/755</b>	<b>78.1620.25N</b>
<b>411/78.1621.25N</b>	<b>900</b>	<b>520</b>	<b>150</b>	<b>15/20</b>	<b>1520</b>	<b>855</b>	<b>16</b>	<b>730/755</b>	<b>78.1621.25N</b>

Valori espressi in millimetri. Value expressed in millimetres.

Legenda tabella e riferimenti optional a pagina 118. Key to table and optional references on page 118

# Oplà Top

PIANO ESTRAIBILE FILO TOP  
PULL-OUT TOP ALLIGNED WITH COUNTER TOP

## DESIGN

Arch. Giulio Manzoni  
ATIM R&S / ATIM R&D

### FINITURA

#### FINISHING

Inox Bronzino

### PORTATA

#### LOAD CAPACITY

40 Kg equamente distribuiti  
40 Kg evenly distributed

### PACKAGING

118x18x8 cm  
4,5 Kg  
0,017 m<sup>3</sup>

### SCORRIMENTO

#### SLIDING

Alluminio / Alluminio  
Aluminium / Aluminium

### OPTIONAL

su richiesta / on request

### KIT TAPPI

#### KIT CAPS

2.9247221.XX



#### NOTE

L'articolo non prevede la fornitura delle parti in legno.  
The item does not include the supply of wooden parts.

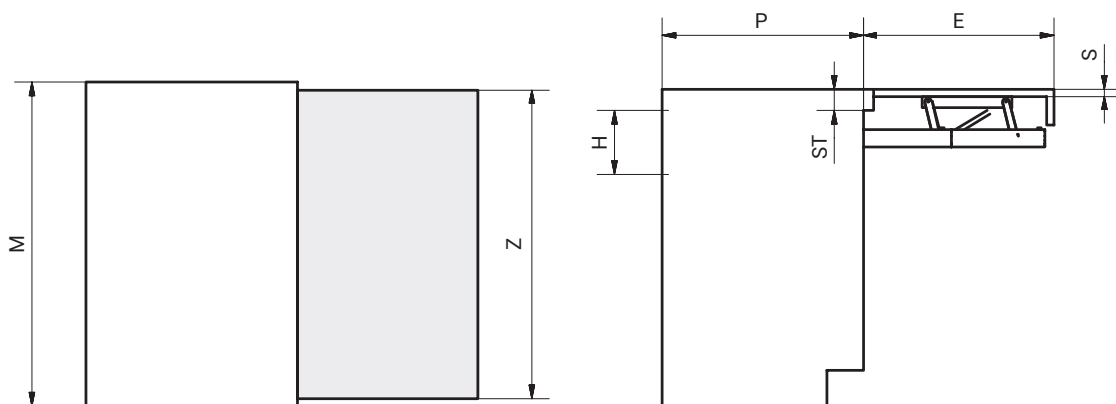

CODICE CODE	M	P min	H min	S1	E	Z min	S	ST	SILENT
411/78.1750.22	450	540	100	15/20	530	405	20/60	20/60	78.1750.22
411/78.1760.22	600	540	100	15/20	530	555	20/60	20/60	78.1760.22
411/78.1770.22	900	540	100	15/20	530	855	20/60	20/60	78.1770.22
411/78.1780.22	1200	540	100	15/20	530	1155	20/60	20/60	78.1780.22

Valori espressi in millimetri. Value expressed in millimetres.

Legenda tabella e riferimenti optional a pagina 118. Key to table and optional references on page 118



# Sandwich

TOP ESTRAIBILE CON EASYBOOK  
PULL-OUT TOP WITH EASYBOOK

## FINITURA FINISHING

Anodizzato naturale (Grigio satinato)  
Anodised aluminium (Gray satin)

## PORTATA LOAD CAPACITY

80 Kg equamente distribuiti  
80 Kg evenly distributed

## PACKAGING

118x18x8 cm  
5,5 Kg  
0,017 m<sup>3</sup>

## SCORRIMENTO SLIDING

Cuscinetti a sfera  
Ball-bearing slide system

## OPTIONAL

su richiesta / on request

## KIT TAPPI KIT CAPS

2.9250551.XX

## CERNIERE HINGES

2.8029912.12

## DESIGN

Arch. Giulio Manzoni  
ATIM R&S / ATIM R&D



## NOTE

L'articolo non prevede la fornitura delle parti in legno.  
The item does not include the supply of wooden parts.

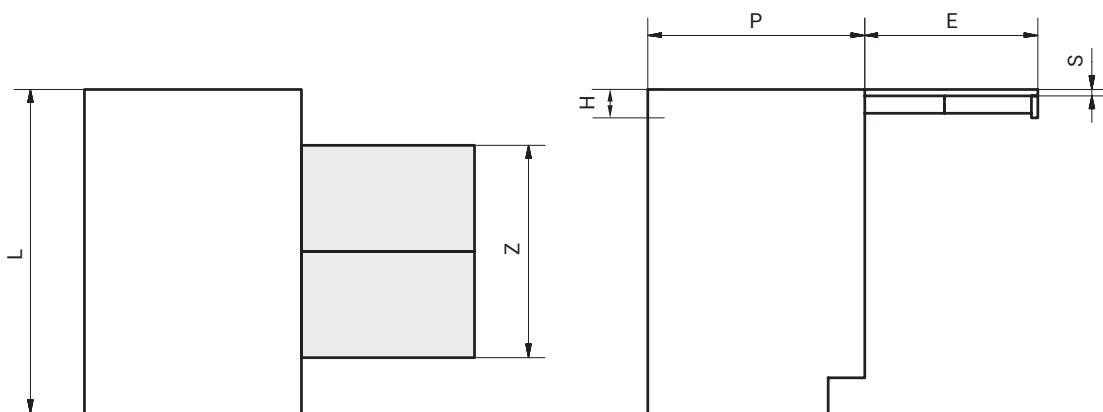

CODICE CODE	L min	P min	H min	E	Z	S
411/78.1850.22	592	540	120	510	590	18
411/78.1860.22	802	540	120	510	800	18
411/78.1870.22	1102	540	120	510	1100	18

Valori espressi in millimetri. Value expressed in millimetres.

Legenda tabella e riferimenti optional a pagina 118. Key to table and optional references on page 118



# Flip Top

PIANO CON EASYBOOK ESTRAIBILE DA CASSETTO  
PULL-OUT DRAWER WORKTOP WITH EASYBOOK

## DESIGN

Arch. Giulio Manzoni  
ATIM R&S / ATIM R&D

### FINITURA

#### FINISHING

Inox Bronzino

### PORTATA

#### LOAD CAPACITY

80 Kg equamente distribuiti

80 Kg evenly distributed

### PACKAGING

118x18x8 cm

5 Kg

0,017 m<sup>3</sup>

### OPTIONAL

su richiesta / on request

### KIT TAPPI

#### KIT CAPS

2.9247221.XX

### CERNIERE

#### HINGES

2.8029912.12



### SCORRIMENTO

#### SLIDING

Alluminio / Alluminio

Aluminium / Aluminium

#### NOTE

L'articolo non prevede la fornitura delle parti in legno.  
The item does not include the supply of wooden parts.

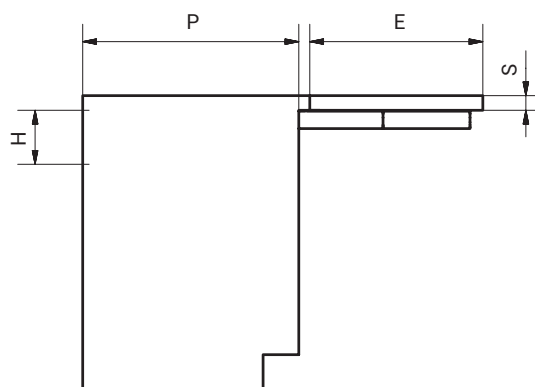
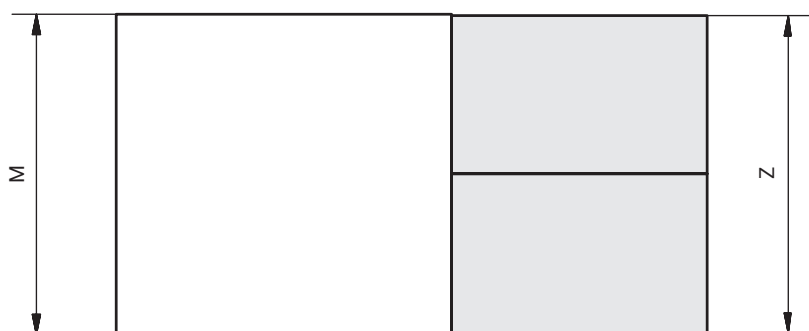

CODICE CODE	M	P min	H min	S1	E	Z min	S min	SILENT
411/78.1800.22	450	540	120	15/20	480	450	16	78.1800.22
411/78.1810.22	600	540	120	15/20	480	600	16	78.1810.22
411/78.1820.22	900	540	120	15/20	480	900	16	78.1820.22

Valori espressi in millimetri. Value expressed in millimetres.

Legenda tabella e riferimenti optional a pagina 118. Key to table and optional references on page 118





# Breakfast

PIANO ESTRAIBILE  
PULL-OUT TOP

## FINITURA FINISHING

Anodizzato naturale (Grigio satinato)  
Anodised aluminium (Gray satin)

## PORTATA LOAD CAPACITY

60 Kg equamente distribuiti  
60 Kg evenly distributed

## PACKAGING

187x17x12 cm  
23,5 Kg  
0,04 m<sup>3</sup>

## SCORRIMENTO SLIDING

Cuscinetti a sfera  
Ball-bearing slide system

## DESIGN

Arch. Giulio Manzoni  
ATIM R&S / ATIM R&D



## NOTE

L'articolo non prevede la fornitura delle parti in legno.  
The item does not include the supply of wooden parts.

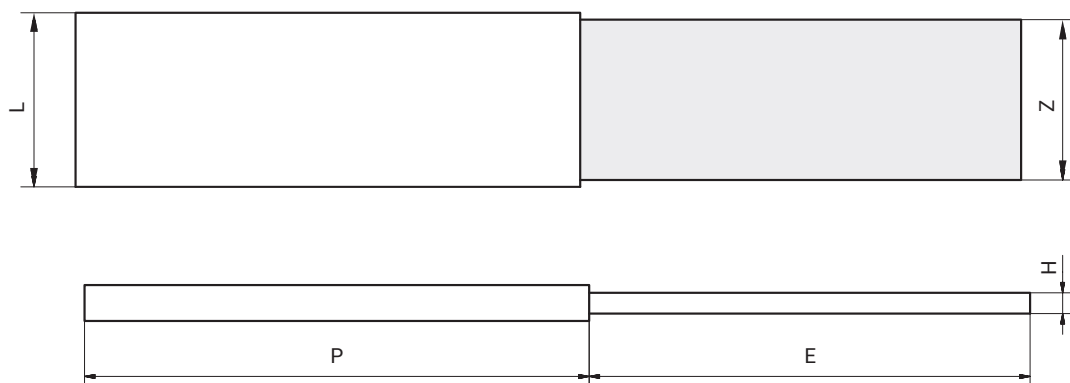

CODICE CODE	L min	P min	H min	E	Z min	S min
411/78.1251.22	600	1780	80	1600	580	18

Valori espressi in millimetri. Value expressed in millimetres.

Legenda tabella e riferimenti optional a pagina 118. Key to table and optional references on page 118



# Breakfast Top

PIANO SCORREVOLE SU TOP  
SLIDING TABLE TOP

## FINITURA

### FINISHING

Anodizzato naturale (Grigio satinato)

*Anodised aluminium (Gray satin)*

## PORTATA

### LOAD CAPACITY

60 Kg equamente distribuiti

*60 Kg evenly distributed*

## PACKAGING

245x16x12 cm

17 Kg

0,05 m<sup>3</sup>

## SCORRIMENTO

### SLIDING

Cuscinetti a sfera

*Ball-bearing slide system*

## DESIGN

Arch. Giulio Manzoni

ATIM R&S / ATIM R&D



## NOTE

L'articolo non prevede la fornitura delle parti in legno.  
*The item does not include the supply of wooden parts.*

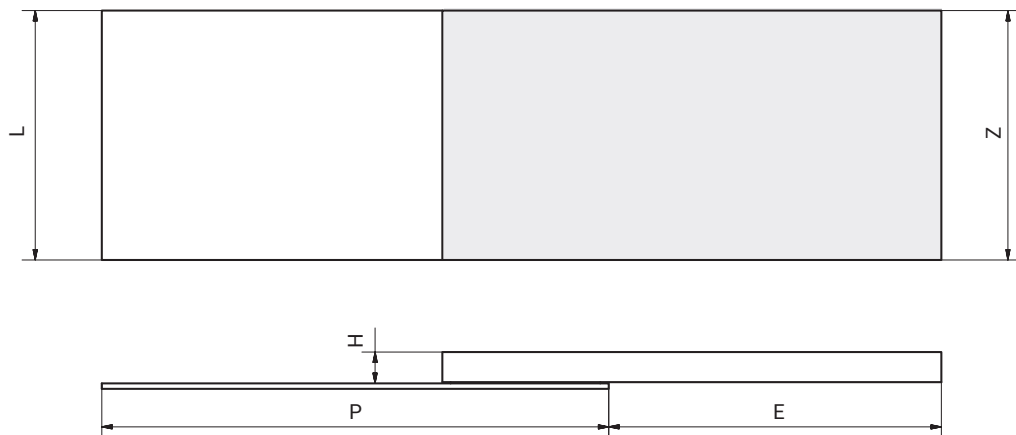

CODICE CODE	P min	H min	Z min	E	S min
411/78.1252.22	1200	85	850	900	18
411/78.1253.22	1800	85	850	1200	18
411/78.1254.22	2400	85	850	1500	18
411/78.1255.22	3000	85	850	1500	18

Valori espressi in millimetri. *Value expressed in millimetres.*

Legenda tabella e riferimenti optional a pagina 118. *Key to table and optional references on page 118*



# Snack

PIANO SCORREVOLE  
SLIDING TABLE TOP

## FINITURA FINISHING

Anodizzato naturale (Grigio satinato)  
Anodised aluminium (Gray satin)

## PORTATA LOAD CAPACITY

80 Kg equamente distribuiti  
80 Kg evenly distributed

## PACKAGING

**411/78.1281.22**  
245x27x8 cm 13,5 Kg 0,05 m<sup>3</sup>

**411/78.1282.22**  
180x27x8 cm 12 Kg 0,04 m<sup>3</sup>

## SCORRIMENTO SLIDING

Cuscinetti a sfera  
Ball-bearing slide system

## OPTIONAL

su richiesta / on request

## KIT TAPPI KIT CAPS

2.9247461.XX

## DESIGN

ATIM R&S / ATIM R&D



## NOTE

L'articolo non prevede la fornitura delle parti in legno.  
The item does not include the supply of wooden parts.

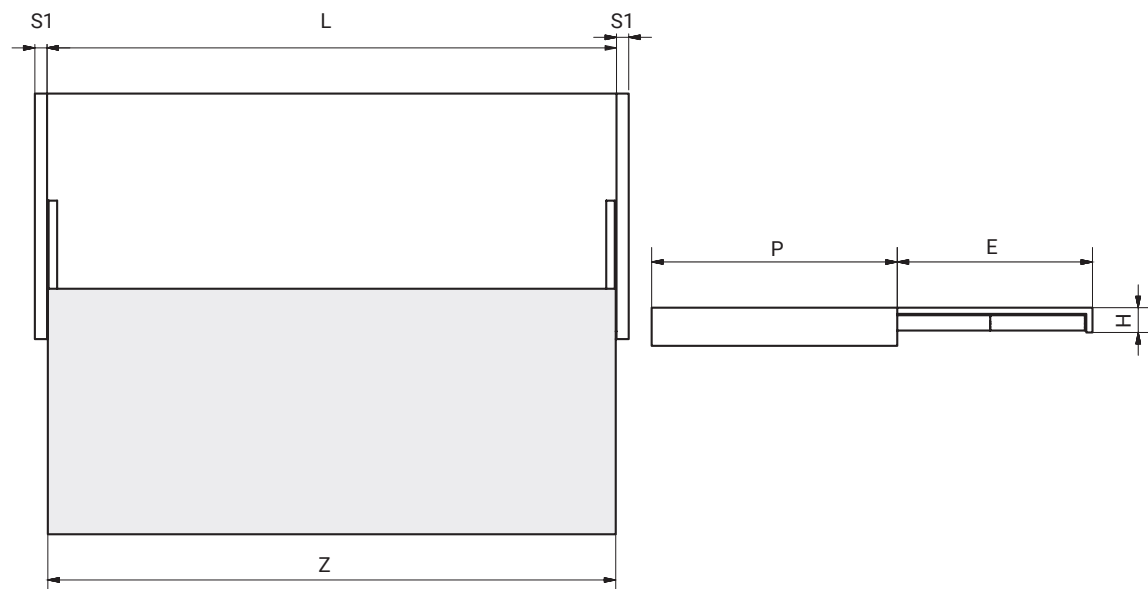

CODICE CODE	L	P min	H min	S1 min	E	S min	Z
411/78.1281.22	2460	800	80	40	640	18	2455
411/78.1282.22	1860	800	80	40	640	18	1855

Valori espressi in millimetri. Value expressed in millimetres.

Legenda tabella e riferimenti optional a pagina 118. Key to table and optional references on page 118



# Snack Top

PIANO SCORREVOLE SU TOP  
SLIDING TABLE TOP

DESIGN  
ATIM R&S / ATIM R&D

## FINITURA FINISHING

Anodizzato naturale (Grigio satinato)  
Anodised aluminium (Gray satin)

## VERSIONE AIR (A) AIR VERSION (A)

Sistema di selfclosing  
Selfclosing system

## PORTATA

### LOAD CAPACITY

80 Kg equamente distribuiti  
80 Kg evenly distributed

### NOTE

L'articolo non prevede la fornitura delle parti in legno.  
The item does not include the supply of wooden parts.

## PACKAGING

### 411/78.1283.22A

90x30x6 cm 9 Kg 0,015 m<sup>3</sup>

### 411/78.1284.22A

120x30x6 cm 13 Kg 0,02 m<sup>3</sup>

### 411/78.1285.22A

90x30x6 cm 9 Kg 0,015 m<sup>3</sup>

## SCORRIMENTO

### SLIDING

Cuscinetti a sfera  
Ball-bearing slide system

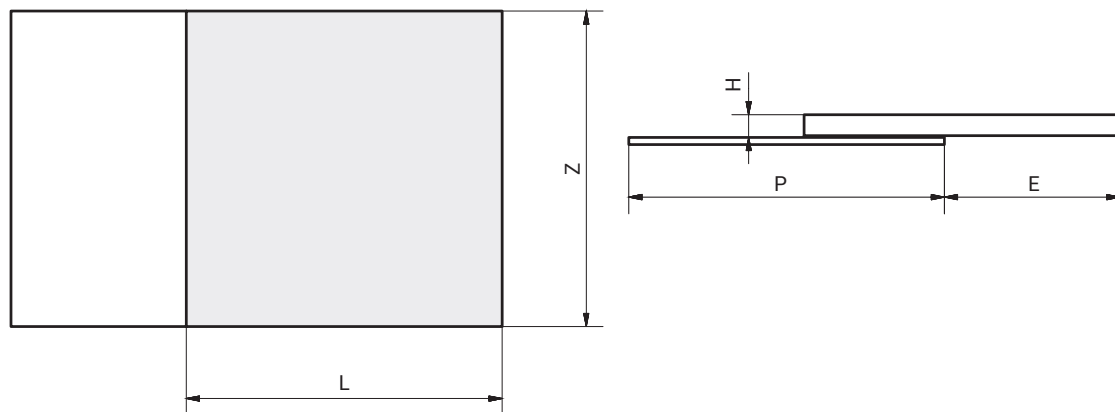

CODICE CODE	P min	Z min	L min	H min	E	S min
411/78.1283.22A	900	900	900	65	500	18
411/78.1284.22A	1200	1200	1200	65	700	18
411/78.1285.22A	900	1200	900	65	500	18

Valori espressi in millimetri. Value expressed in millimetres.

Legenda tabella e riferimenti optional a pagina 118. Key to table and optional references on page 118





# Flap

PIANO SCORREVOLE SU TOP  
SLIDING TABLE TOP

## FINITURA

### FINISHING

Anodizzato naturale (Grigio satinato)

*Anodised aluminium (Gray satin)*

## PORTATA

### LOAD CAPACITY

80 Kg equamente distribuiti

*80 Kg evenly distributed*

## PACKAGING

118x19x15 cm

9 Kg

0,035 m<sup>3</sup>

## SCORRIMENTO

### SLIDING

Cuscinetti a sfera

*Ball-bearing slide system*

## DESIGN

Arch. Giulio Manzoni

ATIM R&S / ATIM R&D



### NOTE

L'articolo non prevede la fornitura delle parti in legno.  
*The item does not include the supply of wooden parts.*

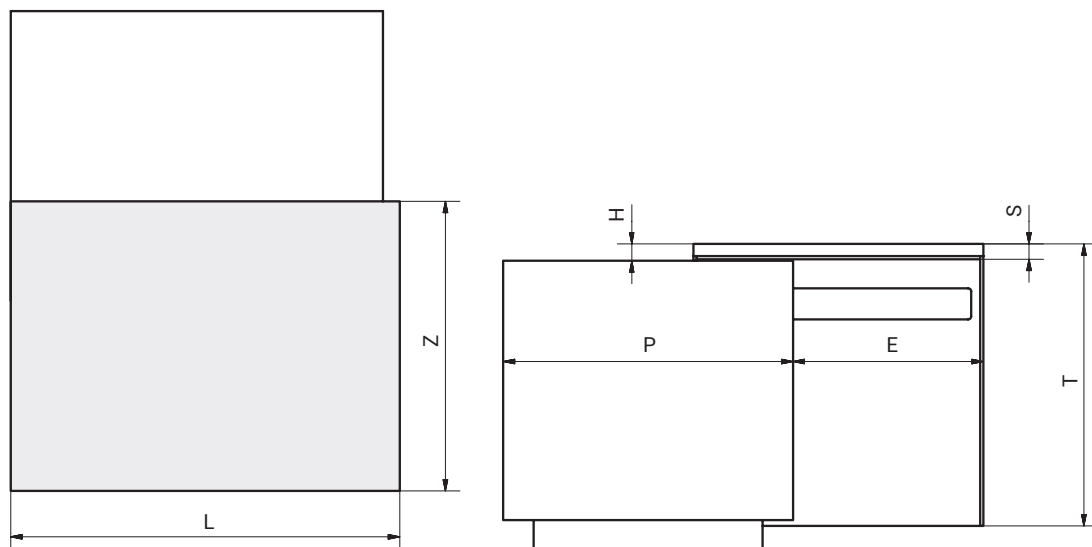

CODICE CODE	P min	H min	S min	E	L	Z	T min
411/78.1244.22	950	55	50	600	600/1300	950	450

Valori espressi in millimetri. *Value expressed in millimetres.*

Legenda tabella e riferimenti optional a pagina 118. *Key to table and optional references on page 118*



# Slide

PIANO SCORREVOLE SU TOP  
CON APERTURA DIAGONALE  
SLIDING TABLE TOP WITH  
DIAGONAL OPENING

## FINITURA FINISHING

Anodizzato naturale (Grigio satinato)  
Anodised aluminium (Gray satin)

## PORTATA LOAD CAPACITY

60 Kg equamente distribuiti  
60 Kg evenly distributed

## PACKAGING

118x46x7 cm  
9 Kg  
0,039 m<sup>3</sup>

## SCORRIMENTO SLIDING

Cuscinetti a sfera  
Ball-bearing slide system

## OPTIONAL

su richiesta / on request

## KIT TAPPI KIT CAPS

2.9250551.XX

## DESIGN

ATIM R&S / ATIM R&D



## NOTE

L'articolo non prevede la fornitura delle parti in legno.  
The item does not include the supply of wooden parts.

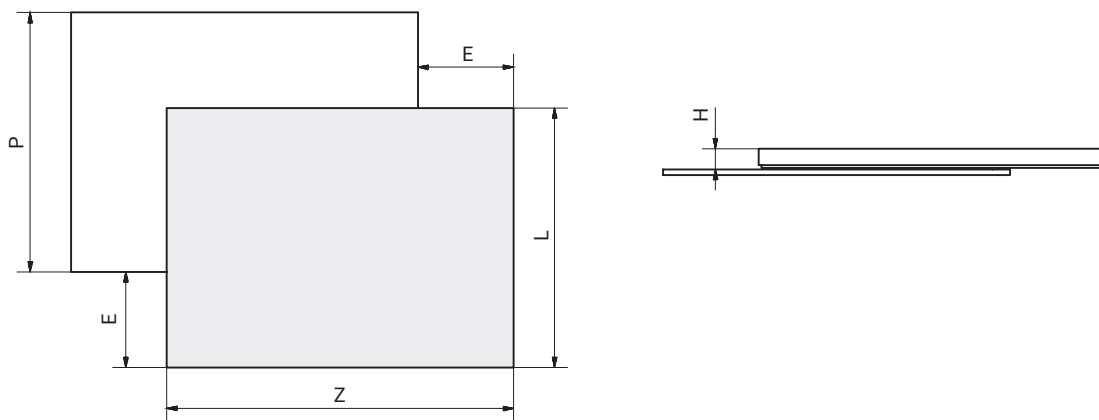

CODICE CODE	APERTURA OPENING	P min	H min	Z	L	S min	E
411/78.1241.22	SX/DX (L/R)	1200	75	1200	1200	18	350
411/78.1242.22	DX (R)	950	75	1200	950	18	350
411/78.1243.22	SX (L)	950	75	1200	950	18	350

Valori espressi in millimetri. Value expressed in millimetres.

Legenda tabella e riferimenti optional a pagina 118. Key to table and optional references on page 118



# Corner

PIANO SCORREVOLE SU TOP  
CON APERTURA DIAGONALE  
*SLIDING TABLE TOP WITH  
DIAGONAL OPENING*

## FINITURA FINISHING

Inox Bronzino

## PORTATA LOAD CAPACITY

60 Kg equamente distribuiti  
*60 Kg evenly distributed*

## PACKAGING

118x46x7 cm  
9 Kg  
0,039 m<sup>3</sup>

## SCORRIMENTO SLIDING

Alluminio / Alluminio  
*Aluminium / Aluminium*

## OPTIONAL

su richiesta / *on request*

**CORNICE IN ALLUMINIO  
RAL 9500 NERO OPACO  
ALUMINIUM FRAME  
RAL 9500 MATT BLACK**

411/78.1430.10  
1200x1200 mm

411/78.1431.10  
1200x900 mm

411/78.1432.10  
900x900 mm

411/78.1433.10  
900x600 mm

## DESIGN

Arch. Giulio Manzoni  
ATIM R&S / ATIM R&D



NOTE  
L'articolo non prevede la fornitura delle parti in legno.  
*The item does not include the supply of wooden parts.*

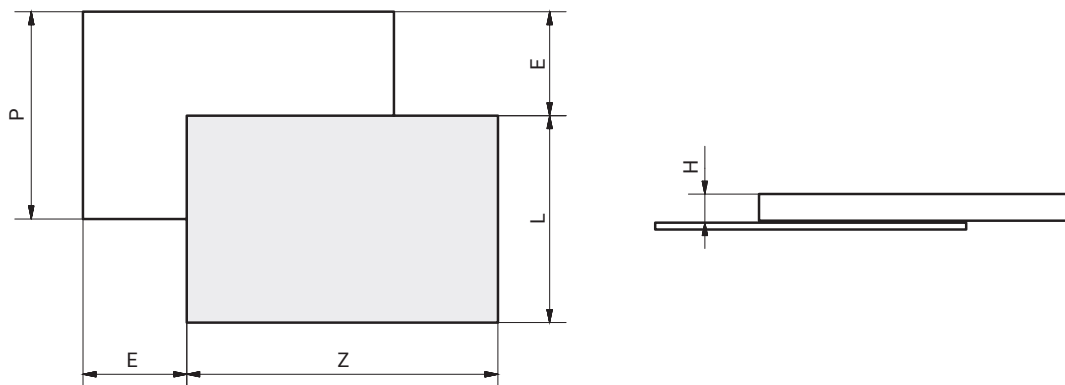

CODICE CODE	APERTURA OPENING	P min	H min	Z	L	S min	E
78.1230.25	SX/DX (L/R)	1200	80	1200	1200	18	350
78.1231.25	DX (R)	900	80	1200	900	18	350
78.1232.25	SX (L)	900	80	1200	900	18	350
78.1233.25	SX/DX (L/R)	900	80	900	900	18	300
78.1234.25	DX (R)	600	80	900	600	18	300
78.1235.25	SX (L)	600	80	900	600	18	300

Valori espressi in millimetri. *Value expressed in millimetres.*

Legenda tabella e riferimenti optional a pagina 118. *Key to table and optional references on page 118*



# Twice Top

PIANO SCORREVOLE SU TOP  
SLIDING TABLE TOP

## DESIGN

Arch. Giulio Manzoni  
ATIM R&S / ATIM R&D

### FINITURA

#### FINISHING

Inox Bronzino

### PORTATA

#### LOAD CAPACITY

60 Kg equamente distribuiti

60 Kg evenly distributed

### PACKAGING

118x18x8 cm

6 Kg

0,017 m<sup>3</sup>

### SCORRIMENTO

#### SLIDING

Alluminio / Alluminio

Aluminium / Aluminium

### OPTIONAL

su richiesta / on request

### KIT TAPPI

#### KIT CAPS

2.9247221.XX

### CORNICE IN ALLUMINIO

#### RAL 9500 NERO OPACO

#### ALUMINIUM FRAME

#### RAL 9500 MATT BLACK

411/78.1431.10

1200x900 mm

411/78.1434.10

1200x600 mm



#### NOTE

L'articolo non prevede la fornitura delle parti in legno.  
The item does not include the supply of wooden parts.

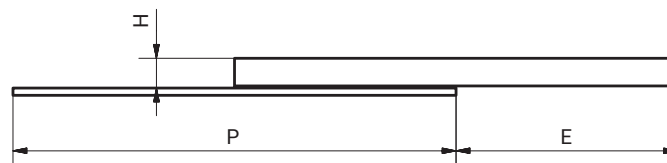
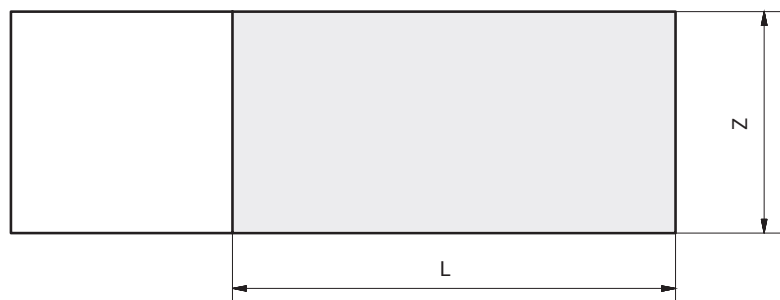

CODICE CODE	P min	H	Z min	L	S min	E
78.1480.25	1200	80	900	1200	14	600
78.1481.25	1200	80	600	1200	14	600

Valori espressi in millimetri. Value expressed in millimetres.

Legenda tabella e riferimenti optional a pagina 118. Key to table and optional references on page 118





# Top 33

PIANO SCORREVOLE SU TOP  
SLIDING TABLE TOP

## FINITURA

### FINISHING

Anodizzato naturale (Grigio satinato)

*Anodised aluminium (Gray satin)*

## PORTATA

### LOAD CAPACITY

60 Kg equamente distribuiti

*60 Kg evenly distributed*

## PACKAGING

118x18x8 cm

7 Kg

0,017 m<sup>3</sup>

## SCORRIMENTO

### SLIDING

Cuscinetti a sfera

*Ball-bearing slide system*

## DESIGN

ATIM R&S / ATIM R&D



## NOTE

L'articolo non prevede la fornitura delle parti in legno.  
*The item does not include the supply of wooden parts.*

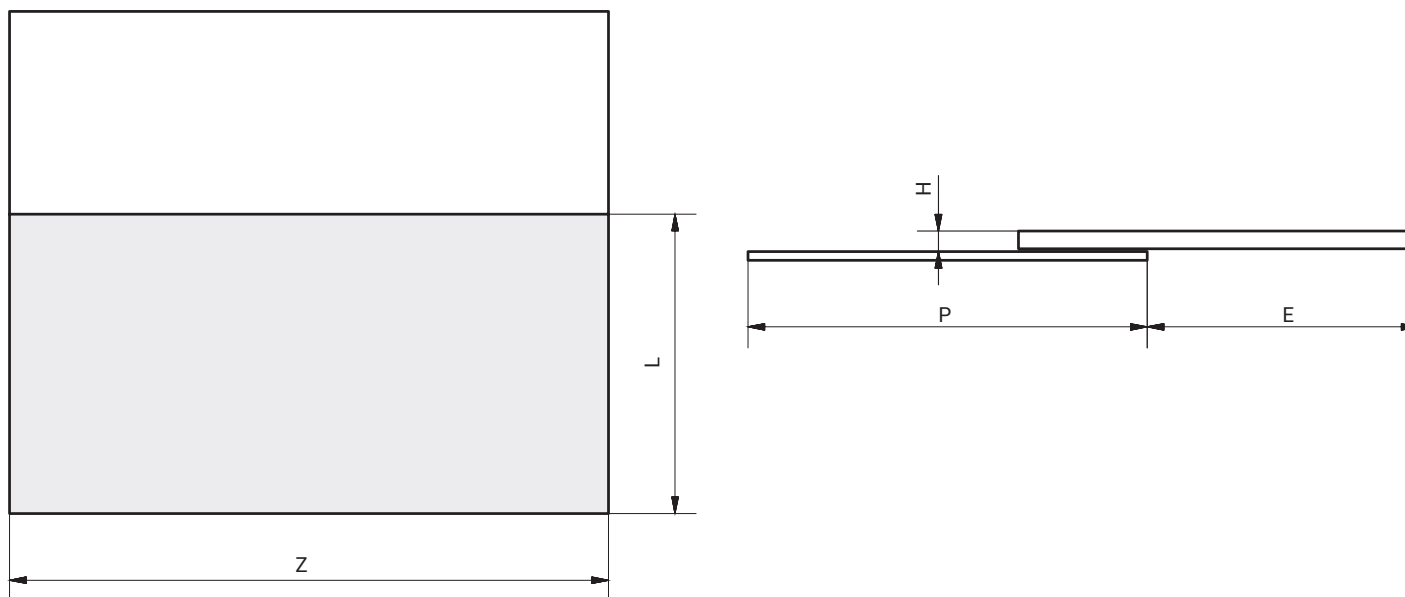

CODICE CODE	P	H min	Z max	L	S min	E
411/78.1270.22	900	45	1800	900	12	610
411/78.1271.22	1200	45	1800	1200	12	710

Valori espressi in millimetri. *Value expressed in millimetres.*

Legenda tabella e riferimenti optional a pagina 118. *Key to table and optional references on page 118*



# Voilà Flag

PIANO ESTRAIBILE CON GAMBE  
PULL-OUT TOP TABLE WITH LEGS

DESIGN

ATIM R&S / ATIM R&D

## FINITURA

### FINISHING

Inox Bronzino

## PORTATA

### LOAD CAPACITY

100 Kg equamente distribuiti

100 Kg evenly distributed

## PACKAGING

105x87x14 cm

13,5 kg

0,13 m<sup>3</sup>

## SCORRIMENTO

### SLIDING

Alluminio / Alluminio

Aluminium / Aluminium

## OPTIONAL

su richiesta / on request

## KIT TAPPI

### KIT CAPS

2.9247311.XX

## CERNIERE

### HINGES

2.8029912.12



## NOTE

L'articolo non prevede la fornitura delle parti in legno.  
The item does not include the supply of wooden parts.

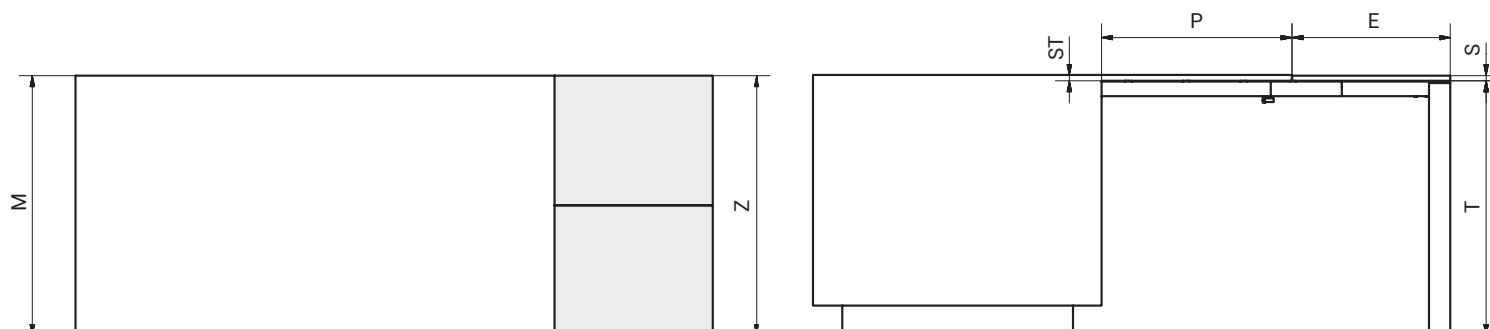

CODICE CODE	M	P min	E	Z min	S max	ST max	T	GAMBA LEG
411/78.1199.25	900	660	570	900	40	40	870/890	72X45

Valori espressi in millimetri. Value expressed in millimetres.

Legenda tabella e riferimenti optional a pagina 118. Key to table and optional references on page 118



# Voilà Chair

PIANO ESTRAIBILE CON GAMBE  
PULL-OUT TOP TABLE WITH LEGS

DESIGN  
ATIM R&S / ATIM R&D

**FINITURA**  
**FINISHING**  
Inox Bronzino

**PORTATA**  
**LOAD CAPACITY**  
100 Kg equamente distribuiti  
100 Kg evenly distributed

**PACKAGING**  
105x87x14 cm  
13,5 kg  
0,13 m<sup>3</sup>

**SCORRIMENTO**  
**SLIDING**  
Alluminio / Alluminio  
Aluminium / Aluminium

**OPTIONAL**  
su richiesta / on request

**KIT TAPPI**  
**KIT CAPS**  
2.9247311.XX

**CERNIERE**  
**HINGES**  
2.8029912.12



NOTE  
L'articolo non prevede la fornitura delle parti in legno.  
The item does not include the supply of wooden parts.

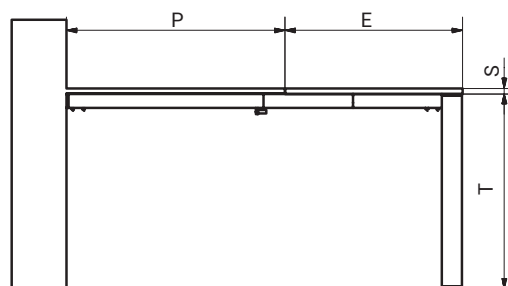
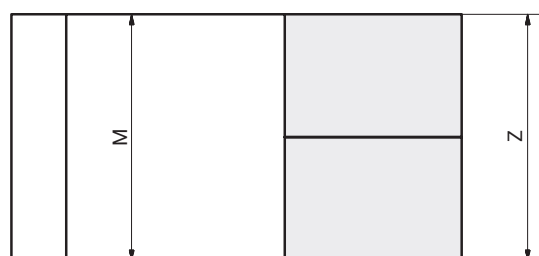

CODICE CODE	M	P	H min	E	Z min	S	T	GAMBA LEG	SILENT
411/78.1330.25	700	800	75	650	700	18/20	707/732	72X45	78.1330.25
411/78.1331.25	700	900	75	650	800	18/20	707/732	72X45	78.1331.25
411/78.1332.25	700	1000	75	650	900	18/20	707/732	72X45	78.1332.25
411/78.1333.25	800	800	75	650	700	18/20	707/732	72X45	78.1333.25
411/78.1334.25	800	900	75	650	800	18/20	707/732	72X45	78.1334.25
411/78.1335.25	800	1000	75	650	900	18/20	707/732	72X45	78.1335.25

Valori espressi in millimetri. Value expressed in millimetres.

Legenda tabella e riferimenti optional a pagina 118. Key to table and optional references on page 118



# Voilà Chair Reverse

DESIGN  
ATIM R&S / ATIM R&D

PIANO A RIBALTA CON GAMBE  
FOLDAWAY TOP TABLE WITH LEGS

## FINITURA

### FINISHING

Inox Bronzino

## PORTATA

### LOAD CAPACITY

100 Kg equamente distribuiti

100 Kg evenly distributed

## PACKAGING

Guide / Slides

118x18x8 cm 6 Kg 0,017 m<sup>3</sup>

Gambe / Legs

105x18x11 cm 7 Kg 0,02 m<sup>3</sup>

## SCORRIMENTO

### SLIDING

Alluminio / Alluminio

Aluminium / Aluminium

## OPTIONAL

su richiesta / on request

## KIT TAPPI

### KIT CAPS

2.9257831.XX

## CERNIERE

### HINGES

2.8029912.12

## VASCA

RAL 9500 NERO OPACO

### TRAY

RAL 9500 MATT BLACK

2.3056941.10 K 700 mm

2.3056951.10 K 800 mm

2.3056961.10 K 900 mm



## NOTE

L'articolo non prevede la fornitura delle parti in legno.  
The item does not include the supply of wooden parts.

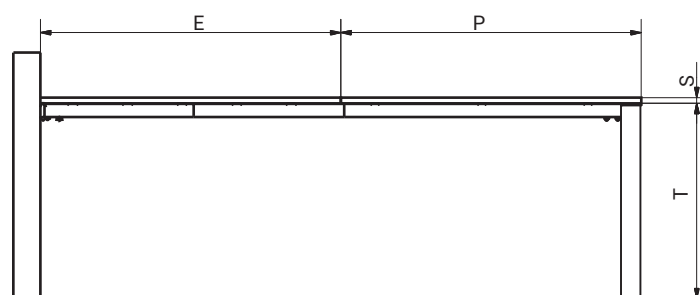

CODICE CODE	M	P	Z	S	E EASYTOUCH	E REVERSE	T	GAMBA LEG	SILENT
411/78.1321.25	700	1300	700	18	800	1300	707/732	72X45	78.1321.25
411/78.1323.25	800	1300	800	18	800	1300	707/732	72X45	78.1323.25
411/78.1325.25	900	1300	900	18	800	1300	707/732	72X45	78.1325.25

Valori espressi in millimetri. Value expressed in millimetres.

Legenda tabella e riferimenti optional a pagina 118. Key to table and optional references on page 118





# Dinamico / Dinamico +

## DESIGN

ATIM R&S / ATIM R&D

PIANO SCORREVOLE CON PROFILO A GOLA  
SLIDING TOP WITH GOLA PROFILE

### FINITURA

#### FINISHING

Guide / Slides  
Inox Bronzino

Gamba in Ferro / Iron Leg  
RAL 9005 Nero Opaco / Matt Blac

Gola  
Inox Bronzino

### PORTATA

#### LOAD CAPACITY

100 Kg equamente distribuiti  
100 Kg evenly distributed

### PACKAGING

Gola  
Ø7x430 cm 3,8kg 1m<sup>3</sup>

Meccanismo / Mechanism  
411/78.1301.25  
42x18x6 cm 8kg 0,005m<sup>3</sup>

411/78.1192.25  
105x87x14 cm 13,5kg 0,13 m<sup>3</sup>

Gamba / Leg  
92x84x14 cm 10kg 0,10 m<sup>3</sup>

### SCORRIMENTO

#### SLIDING

Alluminio / Aluminium  
+ Cuscinetti a sfera  
+ Pattini a pavimento

Aluminium / Aluminium  
+ Ball-bearing slide system  
+ Floor runner

### OPTIONAL

su richiesta / on request

### KIT TAPPI

#### KIT CAPS

2.9247311.XX

### CERNIERE

#### HINGES

2.8029912.12

#### NOTE

L'articolo non prevede la fornitura delle parti in legno.  
L'articolo viene venduto con gola in barra 4300 mm.  
The item does not include the supply of wooden parts.  
The item is sold with a 4300 mm gola rod.

Gola

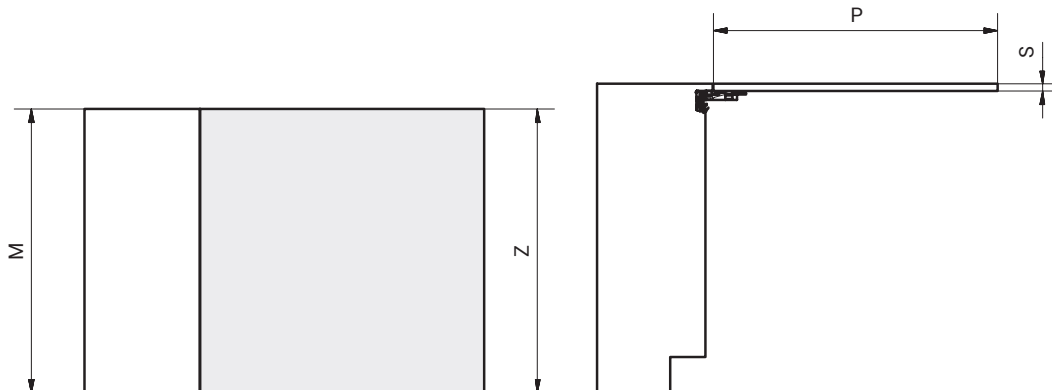
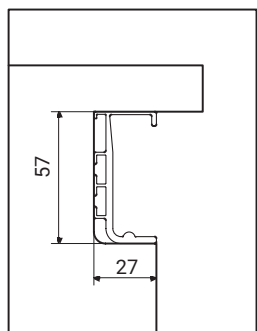

## Dinamico

PROFILO GOLA + STAFFE  
GOLA PROFILE + BRACKETS

CODICE CODE	M min	P min	Z min	S min
411/78.1301.25	500	500	500	20

Valori espressi in millimetri. Value expressed in millimetres.

Legenda tabella e riferimenti optional a pagina 118. Key to table and optional references on page 118

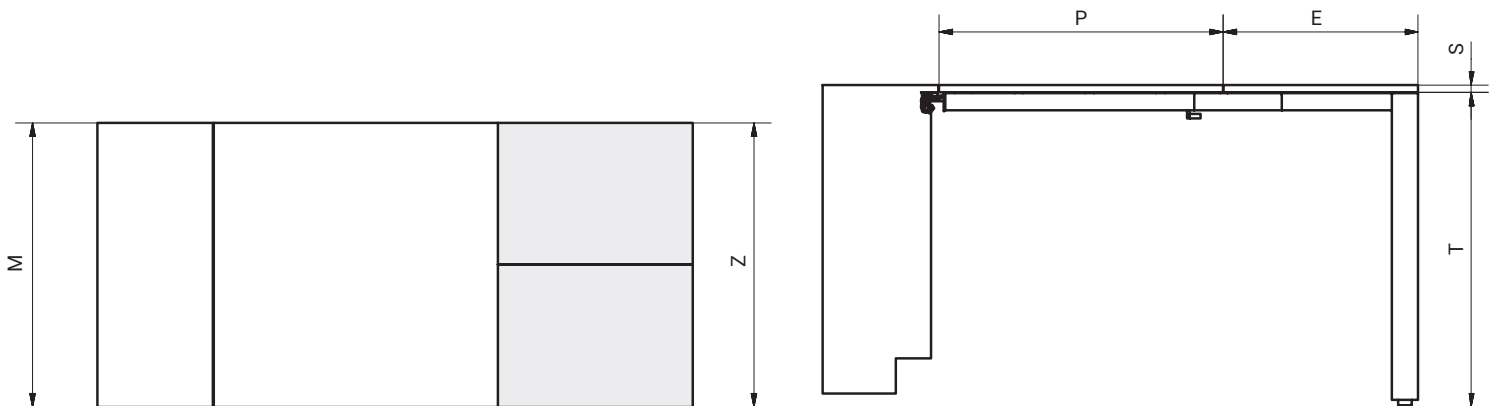

## Dinamico+

PROFILO GOLA + STAFFE + MECCANISMO ALLUNGABILE + GAMBA  
 GOLA PROFILE + BRACKETS + EXTENDABLE MECHANISM + LEG

CODICE CODE	M	P min	Z min	E	S	T	SILENT
411/78.1192.25	800	800	800	550	20	800/960	78.1192.25

Valori espressi in millimetri. Value expressed in millimetres.

Legenda tabella e riferimenti optional a pagina 118. Key to table and optional references on page 118

# Sestante

PIANO SCORREVOLE E GIREVOLE SU TOP  
SLIDING AND REVOLVING TABLE TOP

## DESIGN

Arch. Giulio Manzoni  
ATIM R&S / ATIM R&D

### FINITURA

#### FINISHING

Guide / Slides

Anodizzato naturale / Anodised aluminium

Gamba in ferro / Iron leg

RAL 9005 Nero opaco / Matt black

### PORTATA

#### LOAD CAPACITY

80 Kg equamente distribuiti

80 Kg evenly distributed

### PACKAGING ( 3 packages )

Guide / Slides

Ø7x130 cm 2.5 Kg 0,006 m<sup>3</sup>

Meccanismo / Mechanism

50x60x25 cm 10 Kg 0,25 m<sup>3</sup>

Gamba / Leg 600

85x65x20 cm 10,5 Kg 0,11 m<sup>3</sup>

Gamba / Leg 700

85x75x20 cm 11,5 Kg 0,13 m<sup>3</sup>

Gamba / Leg 800

85x85x20 cm 12,5 Kg 0,14 m<sup>3</sup>

Gamba / Leg 900

85x95x20 cm 13,5 Kg 0,16 m<sup>3</sup>

Gamba / Leg 1200

85x125x20 cm 16,5 Kg 0,21 m<sup>3</sup>

### SCORRIMENTO

#### SLIDING

Cuscinetti a sfera

Ball-bearing slide system

#### NOTE

L'articolo non prevede la fornitura delle parti in legno.

411/78.129X.22: fornito senza gamba.

I codici con la "R" includono la gamba regolabile.

The item does not include the supply of wooden parts.

411/78.129X.22: supplied without leg.

The "R" codes are supplied with adjustable leg.

> L'ARTICOLO È COPERTO DA BREVETTO  
THE ITEM IS PATENT PROTECTED

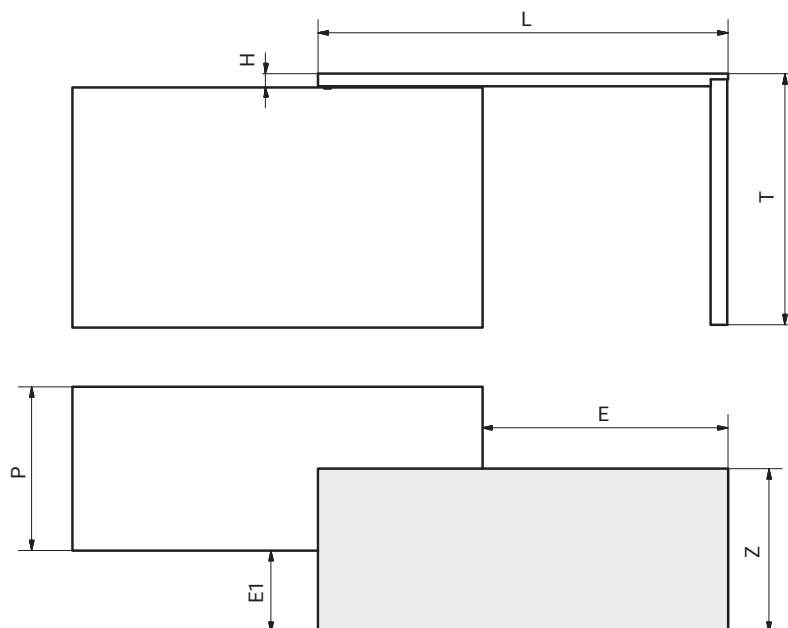

CODICE CODE	P	L	T	H	E	E1	Z	S min
411/78.129X.22	-	1500	-	55	900	300	-	18
411/78.1290.22R	600	1500	800/960	55	900	300	600	18
411/78.1291.22R	700	1500	800/960	55	900	300	700	18
411/78.1292.22R	800	1500	800/960	55	900	300	800	18
411/78.1293.22R	900	1500	800/960	55	900	300	900	18
411/78.1294.22R	1200	1500	800/960	55	900	300	1200	18

Valori espressi in millimetri. Value expressed in millimetres.

Legenda tabella e riferimenti optional a pagina 118. Key to table and optional references on page 118



# Evolution +39 / Evolution XL +39

## DESIGN

Arch. Giulio Manzoni  
ATIM R&S / ATIM R&D

TAVOLO ESTRAIBILE DA CABINET CON GAMBA A PONTE  
PULL-OUT CABINET TABLE WITH BRIDGE LEG

### FINITURA

#### FINISHING

Guide / Slides  
Inox Bronzino

Gamba / Leg

Grigio / Grey Ral 7012

Versione Naked (N)

Naked Version (N)

Gamba

Nero opaco RAL 9005.

Senza traversi per fissaggio anta

Leg

Matt black RAL 9005.

Without bar for door fixing

### PORTATA

#### LOAD CAPACITY

100 Kg equamente distribuiti

100 Kg evenly distributed

### SCORRIMENTO

#### SLIDING

Alluminio / Alluminio

Aluminium / Aluminium

### PACKAGING (2 packages)

Evolution +39 / Evolution +39 Naked

411/39.1610.25 411/39.1610.25N

118x18x8 cm 4,5 Kg 0,017 m<sup>3</sup>

57x77x8 cm 8 Kg 0,035 m<sup>3</sup>

411/39.1611.25 411/39.1611.25N

118x18x8 cm 4,5 Kg 0,017 m<sup>3</sup>

87x88x8 cm 11 Kg 0,055 m<sup>3</sup>

Evolution XL +39 / Evolution XL +39 Naked

411/39.1620.25 411/39.1620.25N

118x18x8 cm 5,5 Kg 0,017 m<sup>3</sup>

57x77x8 cm 8 Kg 0,035 m<sup>3</sup>

411/39.1621.25 411/39.1621.25N

118x18x8 cm 5,5 Kg 0,017 m<sup>3</sup>

87x88x8 cm 11 Kg 0,055 m

### OPTIONAL

su richiesta / on request

### KIT TAPPI

#### KIT CAPS

Evolution +39 2.9247241.XX

Evolution XL +39 2.9247271.XX

### CERNIERE

#### HINGES

2.8029912.12

### NOTE

L'articolo non prevede la fornitura delle parti in legno.

Versione Naked (N): non prevede i traversi per il fissaggio dell'anta.

The item does not include the supply of wooden parts.

Naked Version (N): does not include crosspieces for fixing the door.

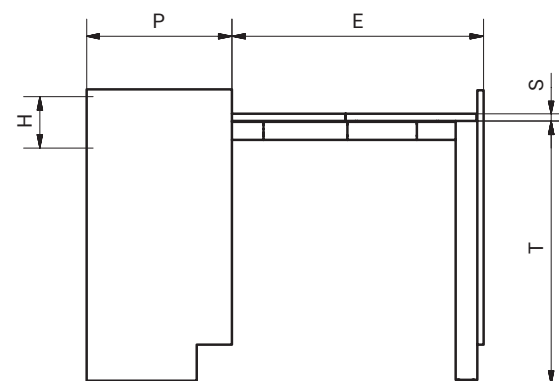
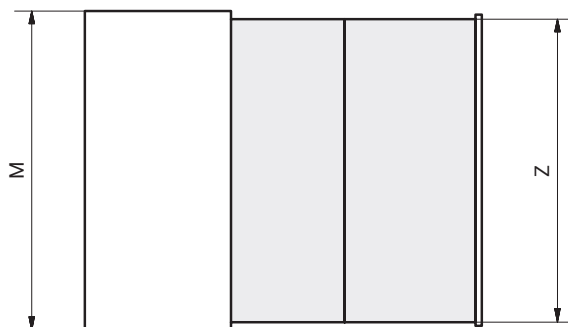

## Evolution +39

CODICE CODE	M	P min	H min	S1	E	S min	Z min	T	SILENT
411/39.1610.25	600	390	120	15/20	690	16	555	730/755	39.1610.25
411/39.1611.25	900	390	120	15/20	690	16	855	730/755	39.1611.25
<b>411/39.1610.25N</b>	<b>600</b>	<b>390</b>	<b>120</b>	<b>15/20</b>	<b>690</b>	<b>16</b>	<b>555</b>	<b>730/755</b>	<b>39.1610.25N</b>
<b>411/39.1611.25N</b>	<b>900</b>	<b>390</b>	<b>120</b>	<b>15/20</b>	<b>690</b>	<b>16</b>	<b>855</b>	<b>730/755</b>	<b>39.1611.25N</b>

Valori espressi in millimetri. Value expressed in millimetres.

Legenda tabella e riferimenti optional a pagina 118. Key to table and optional references on page 118

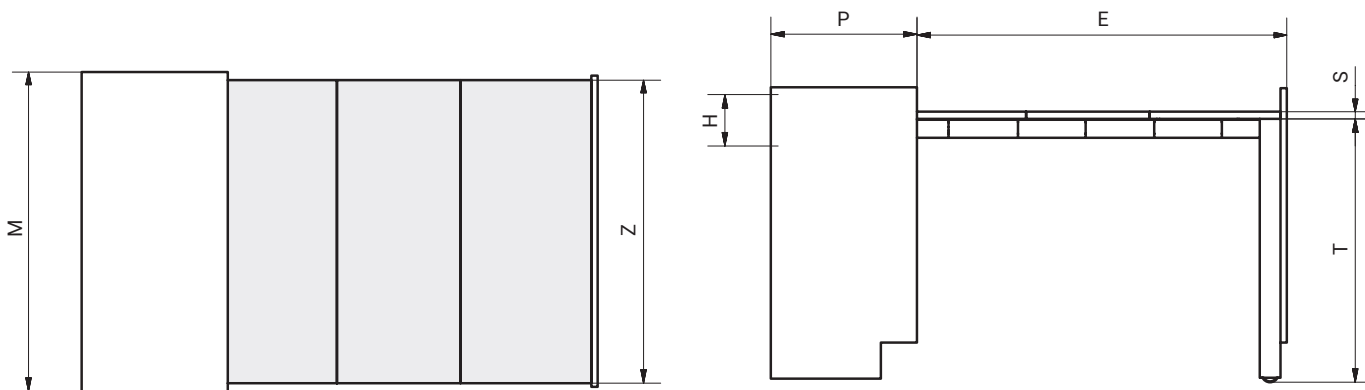

### Evolution XL +39

CODICE CODE	M	P min	H min	S1	E	S min	Z min	T	SILENT
411/39.1620.25	600	390	150	15/20	1025	16	555	730/755	39.1620.25
411/39.1621.25	900	390	150	15/20	1025	16	855	730/755	39.1621.25
<b>411/39.1620.25N</b>	<b>600</b>	<b>390</b>	<b>150</b>	<b>15/20</b>	<b>1025</b>	<b>16</b>	<b>555</b>	<b>730/755</b>	<b>39.1620.25N</b>
<b>411/39.1621.25N</b>	<b>900</b>	<b>390</b>	<b>150</b>	<b>15/20</b>	<b>1025</b>	<b>16</b>	<b>855</b>	<b>730/755</b>	<b>39.1621.25N</b>

Valori espressi in millimetri. Value expressed in millimetres.

Legenda tabella e riferimenti optional a pagina 118. Key to table and optional references on page 118

# Mensola T-Able +39

TAVOLO CON GAMBA SINGOLA ABBATTIBILE  
TELESCOPICA ESTRAIBILE DA CASSETTO  
*PULL-OUT DRAWER TABLE WITH SINGLE  
TELESCOPIC FOLDING LEG*

## DESIGN

Arch. Giulio Manzoni  
ATIM R&S / ATIM R&D

### FINITURA

#### FINISHING

Inox Bronzino

### PORTATA

#### LOAD CAPACITY

100 Kg equamente distribuiti

*100 Kg evenly distributed*

### PACKAGING

104x34x8 cm

8 Kg

0,03 m<sup>3</sup>

### SCORRIMENTO

#### SLIDING

Alluminio / Alluminio

*Aluminium / Aluminium*

### OPTIONAL

su richiesta / *on request*

### KIT TAPPI

#### KIT CAPS

2.9247261.XX



### NOTE

L'articolo non prevede la fornitura delle parti in legno e di componenti per il fissaggio a parete.  
*The item does not include the supply of wooden parts and components for fixing it to the wall.*

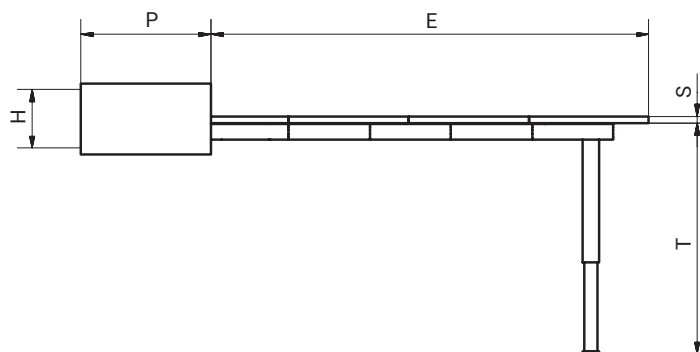
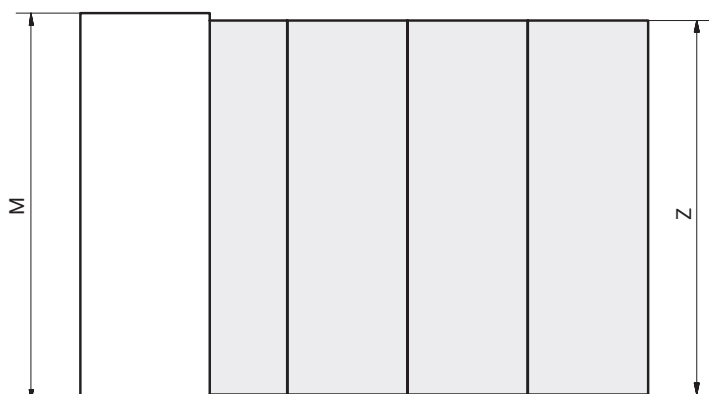

CODICE CODE	M	P min	H min	S1	E	Z min	S min	T	SILENT
411/39.1920.25X	1200	390	180	15/20	1350	1155	14	712/737	39.1920.25X

Valori espressi in millimetri. *Value expressed in millimetres.*

Legenda tabella e riferimenti optional a pagina 118. *Key to table and optional references on page 118*





# T-Bench +39

SEDUTA CON GAMBA SINGOLA  
ABBATTIBILE ESTRAIBILE DA CASSETTO  
PULL-OUT DRAWER BENCH  
WITH SINGLE FOLDING LEG

## DESIGN

Arch. Giulio Manzoni  
ATIM R&S / ATIM R&D

### FINITURA

#### FINISHING

Inox Bronzino

### PORTATA

#### LOAD CAPACITY

100 Kg equamente distribuiti

100 Kg evenly distributed

### PACKAGING

118x18x8 cm

5 Kg

0,017 m<sup>3</sup>

### SCORRIMENTO

#### SLIDING

Alluminio / Alluminio

Aluminium / Aluminium

### OPTIONAL

su richiesta / on request

### KIT TAPPI

#### KIT CAPS

2.9247231.XX

### CERNIERE

#### HINGES

2.8029912.12

### NOTE

L'articolo non prevede la fornitura delle parti in legno.  
The item does not include the supply of wooden parts.

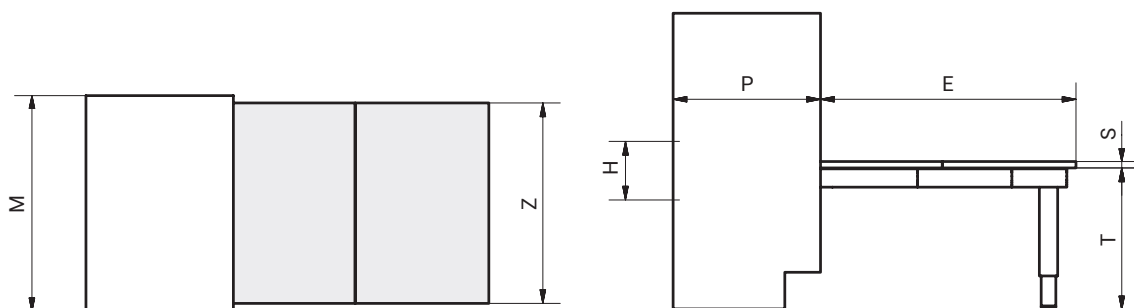

CODICE CODE	M	P min	H min	S1	E	S min	Z min	T	SILENT
411/39.1950.25	450	390	120	15/20	705	16	405	395/420	39.1950.25
411/39.1960.25	600	390	120	15/20	705	16	555	395/420	39.1960.25

Valori espressi in millimetri. Value expressed in millimetres.

Legenda tabella e riferimenti optional a pagina 118. Key to table and optional references on page 118



# Lunch +39

TAVOLO ESTRAIBILE DA CASSETTO  
PULL-OUT DRAWER TABLE

## DESIGN

Arch. Giulio Manzoni  
ATIM R&S / ATIM R&D

### FINITURA

#### FINISHING

Inox Bronzino

### PORTATA

#### LOAD CAPACITY

60 Kg equamente distribuiti

60 Kg evenly distributed

### PACKAGING

118x18x8 cm

3,5 Kg

0,017 m<sup>3</sup>

### SCORRIMENTO

#### SLIDING

Alluminio / Alluminio

Aluminium / Aluminium

### OPTIONAL

su richiesta / on request

### KIT TAPPI

#### KIT CAPS

2.9247231.XX

### CERNIERE

#### HINGES

2.8029912.12



#### NOTE

L'articolo non prevede la fornitura delle parti in legno.  
The item does not include the supply of wooden parts.

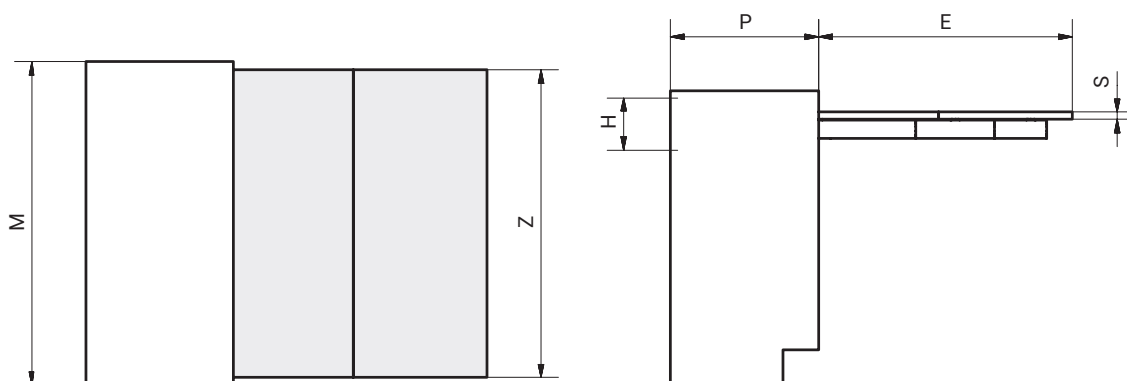

CODICE CODE	M	P min	H min	S1	E	Z min	S min	SILENT
411/39.1100.25	450/1200	390	120	15/20	705	405/1155	16	39.1100.25

Valori espressi in millimetri. Value expressed in millimetres.

Legenda tabella e riferimenti optional a pagina 118. Key to table and optional references on page 118



# Homework +39

TAVOLO ABBATTIBILE A SOFFIETTO  
FOLD-OUT TABLE

## FINITURA

### FINISHING

Inox Bronzino

## PORTATA

### LOAD CAPACITY

40 Kg equamente distribuiti

40 Kg evenly distributed

## PACKAGING

118x18x8 cm

5 Kg

0,017 m<sup>3</sup>

## SCORRIMENTO

### SLIDING

Alluminio / Alluminio

Aluminium / Aluminium

## OPTIONAL

su richiesta / on request

## KIT TAPPI

### KIT CAPS

2.9247251.XX

## KIT HOMEWORK

Cerniere + Push Pull

Hinges + Push Pull

2.9248320.XX

## DESIGN

Arch. Giulio Manzoni

ATIM R&S / ATIM R&D



## NOTE

L'articolo non prevede la fornitura delle parti in legno.  
The item does not include the supply of wooden parts.

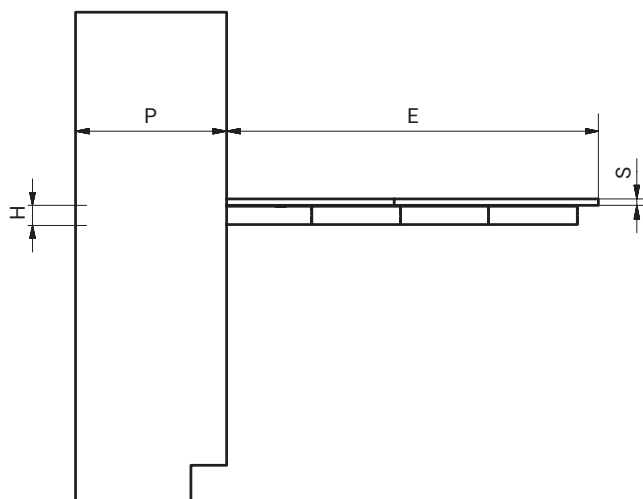

CODICE CODE	M	P min	H	S1	E	Z min	S min	SILENT
411/39.1200.25	600	390	54	15/20	1015	555	16	39.1200.25
411/39.1210.25	900	390	54	15/20	1015	855	16	39.1210.25
411/39.1220.25	1200	390	54	15/20	1015	1155	16	39.1220.25

Valori espressi in millimetri. Value expressed in millimetres.

Legenda tabella e riferimenti optional a pagina 118. Key to table and optional references on page 118



# Oplà +39

PIANO ESTRAIBILE FILO RIPIANO  
PULL-OUT TOP FLUSH WITH SHELF

## FINITURA

### FINISHING

Inox Bronzino

## PORTATA

### LOAD CAPACITY

40 Kg equamente distribuiti

40 Kg evenly distributed

## PACKAGING

118x18x8 cm

3 Kg

0,017 m<sup>3</sup>

## SCORRIMENTO

### SLIDING

Alluminio / Alluminio

Aluminium / Aluminium

## OPTIONAL

su richiesta / on request

## KIT TAPPI

### KIT CAPS

2.9247221.XX

## DESIGN

Arch. Giulio Manzoni

ATIM R&S / ATIM R&D



## NOTE

L'articolo non prevede la fornitura delle parti in legno.  
The item does not include the supply of wooden parts.

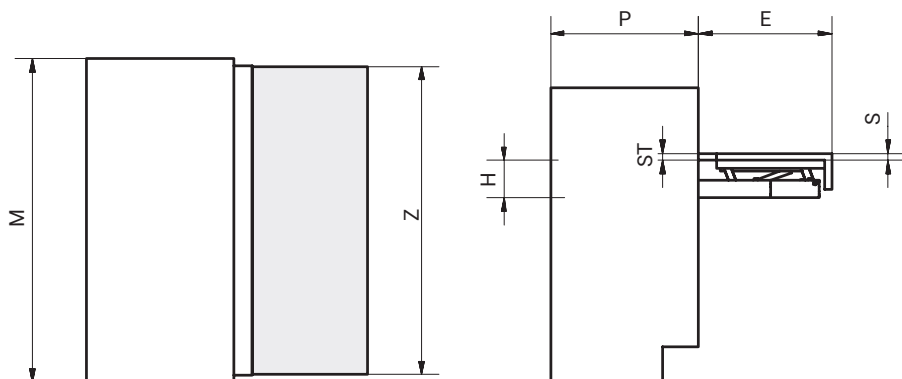

CODICE CODE	M	P min	H min	S1	E	S	ST	Z	SILENT
411/39.1700.25	450/1100	390	100	15/20	370	18/22	18/22	405/1055	39.1700.25
411/39.1720.25	1200	390	100	15/20	370	18/22	18/22	1155	39.1720.25

Valori espressi in millimetri. Value expressed in millimetres.

Legenda tabella e riferimenti optional a pagina 118. Key to table and optional references on page 118





# Oplà Folding +39

PIANO ESTRAIBILE FILO RIPIANO  
PULL-OUT TOP FLUSH WITH SHELF

## DESIGN

Arch. Giulio Manzoni  
ATIM R&S / ATIM R&D

### FINITURA

#### FINISHING

Inox Bronzino

### PORTATA

#### LOAD CAPACITY

40 Kg equamente distribuiti

40 Kg evenly distributed

### PACKAGING

118x18x8 cm

4,5 Kg

0,017 m<sup>3</sup>

### SCORRIMENTO

#### SLIDING

Alluminio / Alluminio

Aluminium / Aluminium

### OPTIONAL

su richiesta / on request

### KIT TAPPI

#### KIT CAPS

2.9247221.XX



### NOTE

L'articolo non prevede la fornitura delle parti in legno.  
The item does not include the supply of wooden parts.

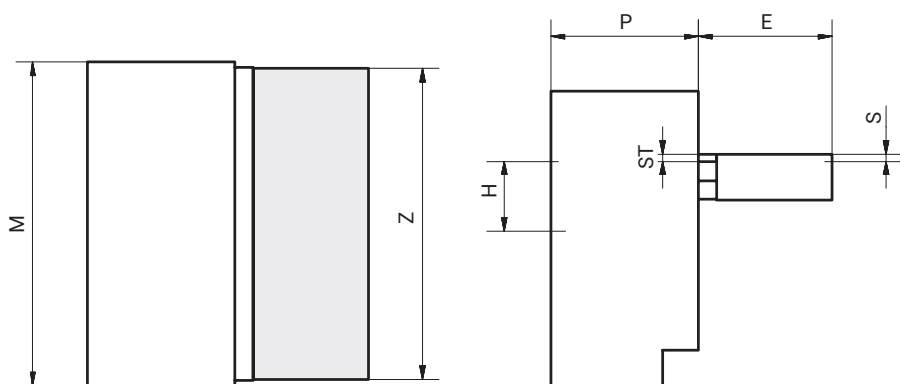

CODICE CODE	M	P min	H min	S1	E	Z	S	ST	SILENT
411/39.1700.25 F	450/1100	390	205	15/20	370	405/1055	16/25	16/25	39.1700.25 F
411/39.1720.25 F	1200	390	205	15/20	370	1155	16/25	16/25	39.1720.25 F

Valori espressi in millimetri. Value expressed in millimetres.

Legenda tabella e riferimenti optional a pagina 118. Key to table and optional references on page 118



# Shot +39

PIANO ESTRAIBILE DA CASSETTO  
PULL-OUT DRAWER WORKTOP

## FINITURA

### FINISHING

Inox Bronzino

## PORTATA

### LOAD CAPACITY

80 Kg equamente distribuiti

80 Kg evenly distributed

## PACKAGING

118x18x8 cm

4 Kg

0,017 m<sup>3</sup>

## SCORRIMENTO

### SLIDING

Alluminio / Alluminio

Aluminium / Aluminium

## OPTIONAL

su richiesta / on request

## KIT TAPPI

### KIT CAPS

2.9247221.XX

## DESIGN

Arch. Giulio Manzoni

ATIM R&S / ATIM R&D



## NOTE

L'articolo non prevede la fornitura delle parti in legno.  
The item does not include the supply of wooden parts.

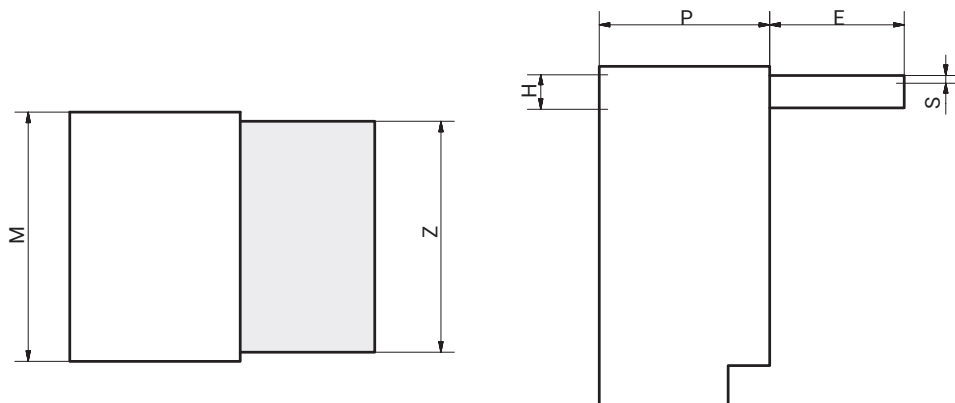

CODICE CODE	M min	P min	H min	S1	E	Z min	S min	SILENT
411/39.1130.25	450	390	90	15/20	325	405	16	39.1130.25

Valori espressi in millimetri. Value expressed in millimetres.

Legenda tabella e riferimenti optional a pagina 118. Key to table and optional references on page 118



# Shot Folding +39

PIANO ESTRAIBILE DA CASSETTO  
PULL-OUT DRAWER WORKTOP

## FINITURA

### FINISHING

Inox Bronzino

## PORTATA

### LOAD CAPACITY

80 Kg equamente distribuiti

80 Kg evenly distributed

## PACKAGING

118x18x8 cm

4 Kg

0,017 m<sup>3</sup>

## SCORRIMENTO

### SLIDING

Alluminio / Alluminio

Aluminium / Aluminium

## OPTIONAL

su richiesta / on request

## KIT TAPPI

### KIT CAPS

2.9247221.XX

## DESIGN

Arch. Giulio Manzoni

ATIM R&S / ATIM R&D



## NOTE

L'articolo non prevede la fornitura delle parti in legno.  
The item does not include the supply of wooden parts.

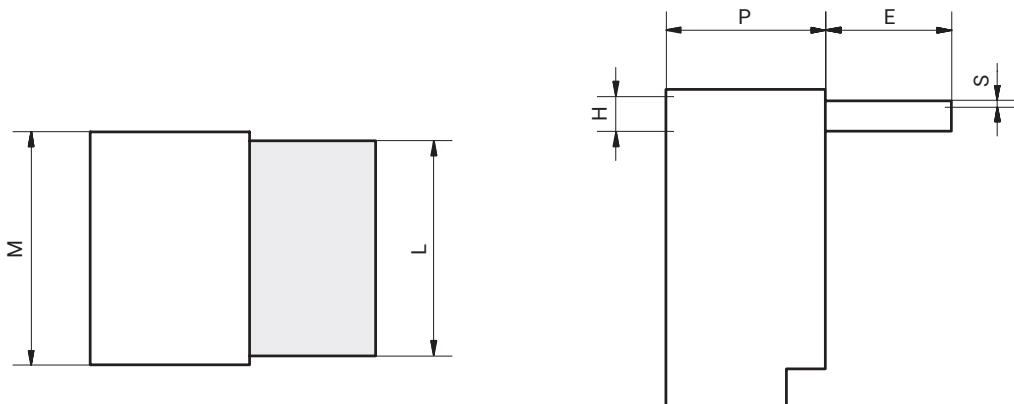

CODICE CODE	M min	P min	H min	S1	E	Z min	S min	SILENT
411/39.1130.25 F	450	390	90	15/20	325	405	16	39.1130.25 F

Valori espressi in millimetri. Value expressed in millimetres.

Legenda tabella e riferimenti optional a pagina 118. Key to table and optional references on page 118



# Prua

ASSE DA STIRO ESTRAIBILE  
PULL-OUT IRONING BOARD

## FINITURA

### FINISHING

Inox Bronzino

## PORTATA

### LOAD CAPACITY

80 Kg equamente distribuiti

80 Kg evenly distributed

## PACKAGING

60x40x14 cm

7,5 Kg

0,035 m<sup>3</sup>

## SCORRIMENTO

### SLIDING

Alluminio / Alluminio

Aluminium / Aluminium

## PIANO

### TOP

Multistrato in betulla fenolico

Phenolic birch plywood

## OPTIONAL

su richiesta / on request

## KIT TAPPI

### KIT CAPS

2.9263681.XX

## PANNO DI RICAMBIO

### SPARE CLOTH

2.6535460.13

## DESIGN

Arch. Giulio Manzoni

ATIM R&S / ATIM R&D



## NOTE

Articolo fornito di piano con tessuto grigio.  
The item is supplied with top and gray cloth.

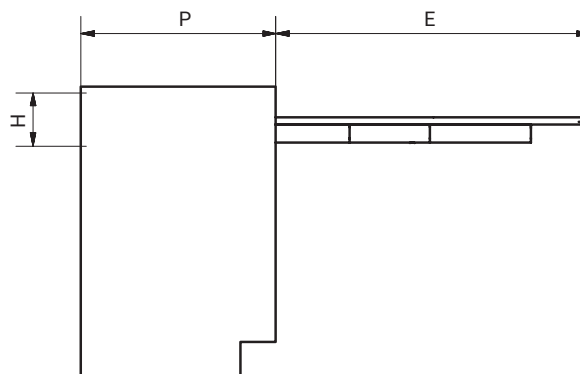
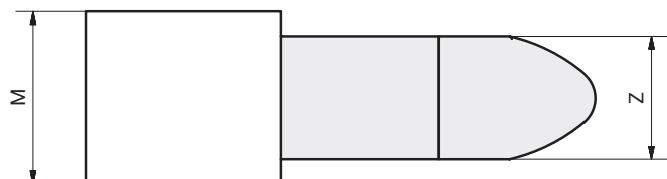

CODICE CODE	M min	P min	H min	E	Z	SILENT
411/78.1180.22	360	535	150	885	350	78.1180.25

Valori espressi in millimetri. Value expressed in millimetres.

Legenda tabella e riferimenti optional a pagina 118. Key to table and optional references on page 118





# Prua Short

ASSE DA STIRO ESTRAIBILE  
PULL-OUT IRONING BOARD

## FINITURA

### FINISHING

Inox Bronzino

## PORTATA

### LOAD CAPACITY

80 Kg equamente distribuiti

80 Kg evenly distributed

## PACKAGING

60x40x14 cm

7,5 Kg

0,035 m<sup>3</sup>

## SCORRIMENTO

### SLIDING

Alluminio / Alluminio

Aluminium / Aluminium

## PIANO

### TOP

Multistrato in betulla fenolico

Phenolic birch plywood

## OPTIONAL

su richiesta / on request

## KIT TAPPI

### KIT CAPS

2.9247231.XX

## PANNO DI RICAMBIO

### SPARE CLOTH

2.6535460.13

## DESIGN

Arch. Giulio Manzoni

ATIM R&S / ATIM R&D



## NOTE

Articolo fornito di piano con tessuto grigio.  
The item is supplied with top and gray cloth.

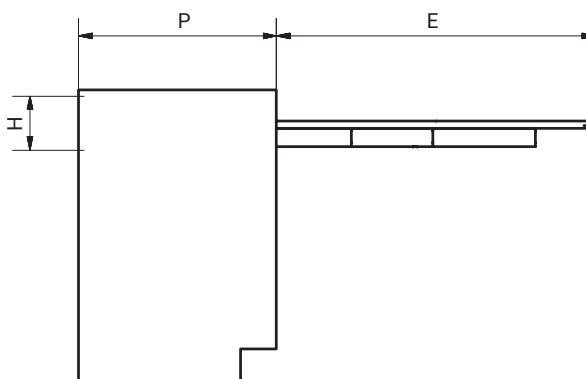
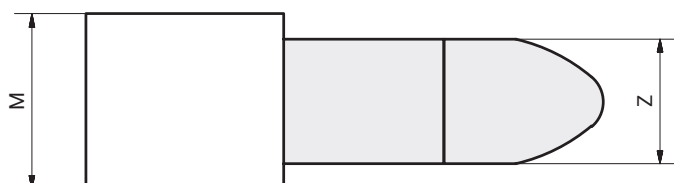

CODICE CODE	M min	P min	H min	E	Z	SILENT
411/78.1181.22	360	450	150	840	350	78.1181.25

Valori espressi in millimetri. Value expressed in millimetres.

Legenda tabella e riferimenti optional a pagina 118. Key to table and optional references on page 118



# Prua Lift

ASSE DA STIRO A RIBALTA  
TILTING IRONING BOARD

DESIGN  
ATIM R&S / ATIM R&D

## FINITURA

### FINISHING

Inox Bronzino

## PORTATA

### LOAD CAPACITY

50 Kg equamente distribuiti

50 Kg evenly distributed

## PACKAGING

120x39x8 cm

6 Kg

0,037 m<sup>3</sup>

## PIANO

### TOP

Multistrato in betulla fenolico

Phenolic birch plywood

## NOTE

Articolo fornito di piano con tessuto grigio.

Il codice con la "R" prevede il fissaggio a ripiano.

The item is supplied with top and gray cloth.

The "R" code refers to system with shelf fixing.

## OPTIONAL

su richiesta / on request

## PANNO DI RICAMBIO

### SPARE CLOTH

Prua Lift 350 2.6551940.13

Prua Lift 450 2.6552110.13

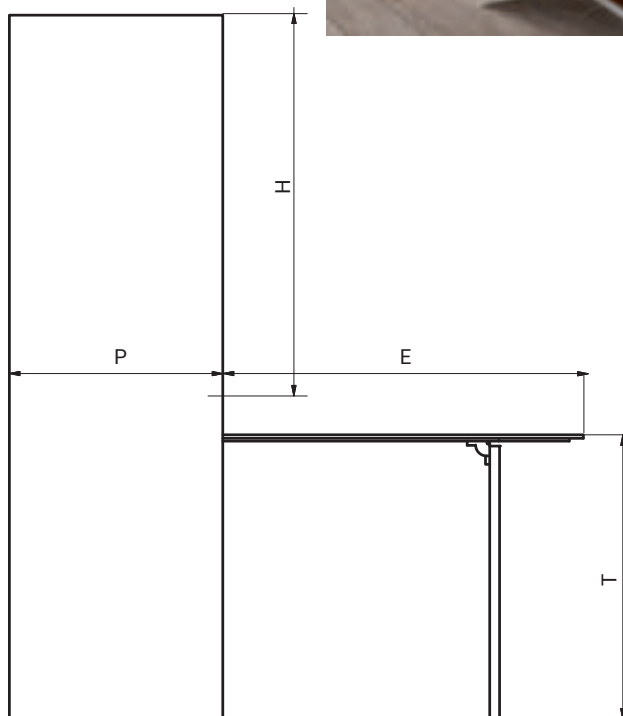
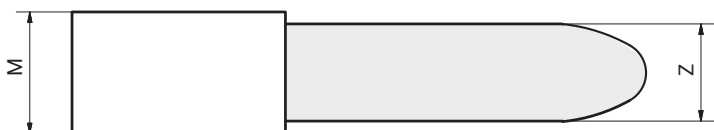

CODICE CODE	M	P min	H min	S1	E	Z	T
411/78.1186.22	350	100	1100	15/20	1050	280	820
411/78.1187.22	450	100	1100	15/20	1050	380	820
411/78.1186.22R	350	100	1100	15/20	1050	280	820

Valori espressi in millimetri. Value expressed in millimetres.

Legenda tabella e riferimenti optional a pagina 118. Key to table and optional references on page 118



# Basket

SACCO LAVANDERIA CON PIANO ESTRAIBILE  
PULL-OUT LAUNDRY BAG WITH TOP

## FINITURA

### FINISHING

Inox Bronzino

## PORTATA

### LOAD CAPACITY

40 Kg equamente distribuiti

40 Kg evenly distributed

## PACKAGING

118x18x8 cm

4 Kg

0,017 m<sup>3</sup>

## SCORRIMENTO

### SLIDING

Alluminio / Alluminio

Aluminium / Aluminium

## OPTIONAL

su richiesta / on request

## KIT TAPPI

### KIT CAPS

2.9249311.XX

## CERNIERE

### HINGES

2.8029912.12

## SACCO DI RICAMBIO

### SPARE CLOTH

Basket 450 2.9149370.27

Basket 600 2.9149380.27

Basket 900 2.9149390.27

## DESIGN

Arch. Giulio Manzoni

ATIM R&S / ATIM R&D



## NOTE

L'articolo non prevede la fornitura delle parti in legno.

L'articolo è fornito con sacco in tessuto.

The item does not include the supply of wooden parts.

The item is supplied with fabric bag.

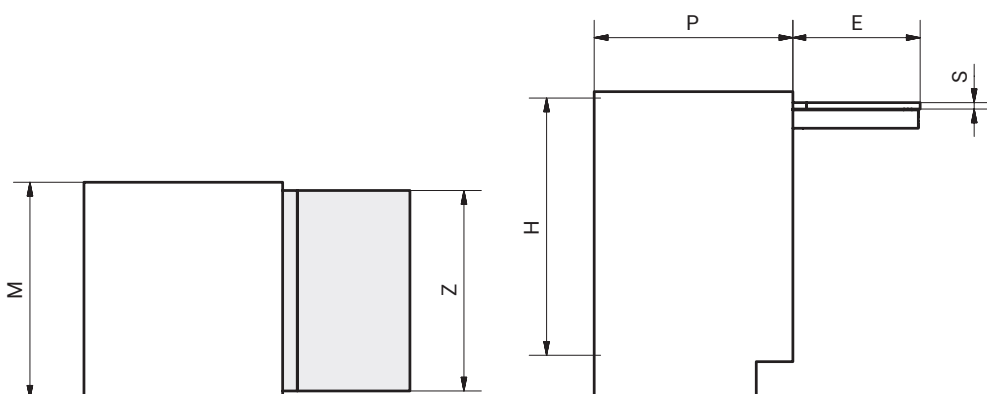

CODICE CODE	M	P min	H min	S1	E	Z	S min	SILENT
411/78.1183.25	450	450	650	15/20	350	405	16	78.1183.25
411/78.1184.25	600	450	650	15/20	350	555	16	78.1184.25
411/78.1185.25	900	450	650	15/20	350	855	16	78.1185.25

Valori espressi in millimetri. Value expressed in millimetres.

Legenda tabella e riferimenti optional a pagina 118. Key to table and optional references on page 118



# DIRECTORY

**M** LARGHEZZA *WIDTH*

**P** PROFONDITÀ *DEPTH*

**H** ALTEZZA *HEIGHT*

**S1** SPESSORE SPALLA *SIDE THICKNESS*

**E** APERTURA PIANO *TOP OPENING*

**Z** LARGHEZZA PIANO *TOP WIDTH*

**S** SPESSORE PIANO *TOP THICKNESS*

**ST** SPESSORE TOP *COUNTERTOP THICKNESS*

**T** ALTEZZA MECCANISMO *MECHANISM HEIGHT*

**L** LARGHEZZA MECCANISMO *MECHANISM WIDTH*

---

## **PERSONALIZZAZIONI**

Tutta la serie dei nostri Trasformabili è personalizzabile in funzione delle esigenze del cliente. Dimensioni, forature, aperture, packaging e gestione, sono alcuni degli aspetti che rendono i nostri prodotti compatibili e complementari con i vostri mobili al 100%.

## **PERSONALIZATION**

*All our Trasformabili series is customizable, depending on our clients' needs. Dimensions, drilling, opening and packaging are only some of the aspects that make our products 100% compatible and complementary to your furniture.*

---

## **SERIE SILENT**

In una continua ricerca di soluzioni e migliorie, il nostro reparto R&S ha studiato ed industrializzato, per tutta la famiglia dei Trasformabili, la versione SILENT. Soluzione che conferisce ai nostri sistemi una silenziosità assoluta. Disponibile su richiesta.

## **SILENT SERIES**

*In a constant search for improvements, our R&D department has studied and industrialized the Silent Series for all the Trasformabili collection. The solution guarantees a substantial noise reduction in all systems. Available on request.*



# OPTIONAL

## KIT TAPPI CAPS KIT

Tappi in ABS grigio per frontale profilo.  
Codice di riferimento nella pagina del prodotto.  
*Gray ABS caps for front profile.  
Reference code on the product page.*



## COVER DESK DESK'S COVER

Tappi in ABS per copertura del meccanismo Desk.  
Codice di riferimento nella pagina del prodotto.  
*ABS caps for mechanical coverage of Desk system.  
Reference code on the product page.*



## CERNIERE HINGES

Spessore cerniera / *Hinge thickness*: 16/22 mm.  
Codice di riferimento nella pagina del prodotto.  
Da ordinare nel quantitativo necessario al prodotto.  
*Reference code on the product page.  
To be ordered in the quantities required by each product.*



## CORNICE IN ALLUMINIO ALUMINIUM FRAME

Cornice in alluminio verniciata.  
Finitura: nero opaco RAL 9005.  
Codice di riferimento nella pagina del prodotto.  
*Painted aluminium frame.  
Finish: matt black RAL 9005.  
Reference code on the product page.*



## PIANO BIANCO WHITE TOP

Piano truciolare melaminico bianco bordato  
ABS 10/10. Codice di riferimento nella pagina del prodotto. Cerniere acquistabili a parte.  
*White chipboard top with ABS 10/10. Reference code on the product page. Hinges available for purchase separately.*



## PIANO ACCIAIO INOX STAINLESS STEEL TOP

Piano multistrato rivestito in acciaio AISI A430.  
Codice di riferimento nella pagina del prodotto.  
*Plywood top covered in AISI A430 steel.  
Reference code on the product page.*

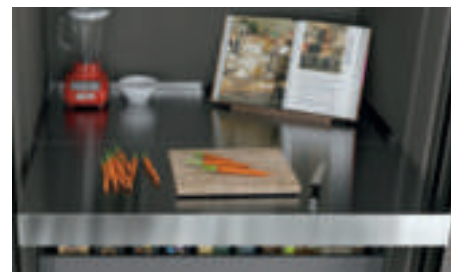

I Trasformabili Atim vengono sottoposti alle prove CATAS che valutano la sicurezza, resistenza e durata dei prodotti in accordo alle norme tecniche nazionali, europee e internazionali.

*Atim's Trasformabili are tested by CATAS, which assesses the safety, strength and durability of the products in accordance with Italian, European and international technical standards.*



# REFERENCES

**COMPOSIT**

**dbgroup**



**HÄFELE**

**LMC**

**LINCOLN SENTRY**

**cuisinella**  
A l'écoute de vos envies

**STOSA**  
CUCINE

**Poliform**

**Hevolus**  
SPECIALIZATI  
IN CUCINE, TAVOLE E ARREDAMENTI

**ARREX**  
LE CUCINE

**Richelieu**

**Gicinque**  
cucine

**SCHMIDT**  
le sur-mesure n'est plus un luxe

**MERCANTINI MOBILI**  
CUCINE, TAVOLE E ARREDAMENTI



**SUGATSUNE**

**Dada**

**RIFLESSI**  
DESIGNED AND MADE IN ITALY

**FAER AMBIENTI**

**PEDINI**

**Veneta Cucine**

**Binova**

**MOBILTURI**  
EVOLUZIONE CUCINA

**dibiesse**  
CUCINE

**COLOMBINI GROUP**  
COLOMBINI CASA febalcasa ROSSANA

**Euromobil**

**Arredo3**  
CUCINE

**clei**  
il fascino dell'ingegno

**Boffi**

**joli**  
designed to last

**TECNOFORM**

**snaldero**  
CUCINE PER LA VITA

**WURTH**

**Givi**

**QAMA**  
QUINCALLETTA





**Concept**

Atim spa

**Photo e render**

Archive Atim spa

**Graphic design and print**

Grafiche Antiga spa

9.2022

La descrizione e le immagini dei prodotti del presente catalogo sono puramente indicative e non possono essere considerate vincolanti ai fini del loro utilizzo. Il contenuto grafico è anche soggetto a copyright e la sua riproduzione, anche parziale, senza previa autorizzazione è vietata a norma di legge. Atim si riserva di apportare ai prodotti modifiche, migliorie tecniche e annullamenti agli articoli di fine serie che siano ritenuti opportuni, in qualsiasi momento e senza alcun preavviso.

Per ulteriori informazioni sulle caratteristiche tecniche dei prodotti, invitiamo a consultare il sito [www.atimspa.com](http://www.atimspa.com) o contattare Atim direttamente

*The description and the images of the products in this catalog are purely indicative and cannot be considered binding for the purposes of their use. The graphic content is subject to copyright and its reproduction, even partial, without prior authorization is prohibited by law. Atim reserves itself the right to make changes, technical improvements and cancellations to discontinued items to the products when deemed appropriate, at any time and without notice.*

*For further information on the technical characteristics of the products, please consult the website [www.atimspa.com](http://www.atimspa.com) or contact Atim directly.*





Uffici  
Produzione  
Showroom

Via IV Novembre, 52  
20019 Settimo Milanese  
Milano - Italy

Tel. +39 02 33503203  
Fax +39 02 33516514

[info@atimspa.com](mailto:info@atimspa.com)  
[atimspa.com](http://atimspa.com)

Per conoscere il tuo rivenditore/rappresentante di zona:  
scrivi a [marketing@atimspa.com](mailto:marketing@atimspa.com)